



Alyza IQ NH4

1 AND 2 CHANNEL MEASURING SYSTEMS FOR ONLINE DETERMINATION
OF AMMONIUM IN AQUEOUS SAMPLES



a xylem brand



For the most recent version of the manual, please visit
www.ysi.com.

Contact YSI
1725 Brannum Lane
Yellow Springs, OH 45387 USA
Tel: +1 937-767-7241
800-765-4974
Email: info@ysi.com
Internet: www.ysi.com

Copyright © 2022 Xylem Inc.

Contents

1	Overview	7
1.1	How to use this component operating manual	7
1.2	Metrological basics <i>NH4-N / NH3-N, NH4</i>	8
1.3	Product description	8
1.3.1	Overview	8
1.3.2	Measuring unit	14
1.3.3	ChemBags	15
1.3.4	Status LEDs	16
1.3.5	Instrument variants	17
1.3.6	Sample filtration	19
1.4	Name plates	20
2	Safety instructions	22
2.1	Safety information	22
2.1.1	Safety information in the operating manual	22
2.1.2	Safety signs on the product	22
2.1.3	Further documents providing safety information	22
2.2	Safe operation	23
2.2.1	Authorized use	23
2.2.2	Requirements for safe operation	23
2.2.3	Unauthorized use	23
2.3	User qualification	23
2.4	Personal protective equipment (PPE)	24
3	Commissioning	25
3.1	IQ SENSORNET system requirements	25
3.2	Scope of delivery	25
3.2.1	Scope of delivery of the Alyza IQ	25
3.2.2	Accessories required in addition	26
3.3	Basic principles of installation	27
3.3.1	Requirements of the measurement location	27
3.3.2	Safety requirements of the electrical installation	27
3.3.3	General installation instructions	28
3.3.4	Installing the housing	30
3.3.5	Installation on the SM stand mount	30
3.3.6	Installation on a rail	35

3.3.7	Installation on a wall	40
3.3.8	Removing the transport protection of the measuring unit	42
3.3.9	Connecting the cables to the control unit ACM	43
3.3.10	Mounting the cover plate for the control unit ACM	44
3.3.11	Installing the bug screen and condensate drain adapter	45
3.3.12	Mounting the terminal holder (TM)	47
3.3.13	Connecting the power cable and heat tracing lines	50
3.3.14	Mounting the collection funnel	59
3.3.15	Mounting the WF Set (collection funnel for sample overflow)	62
3.3.16	Installing the FM/PC filter module and M 1.5 basin holder for filtration	64
3.3.17	Connecting the tubes and liquid lines	66
3.3.18	Setting up a connection with the IQ SENSORNET system	69
3.3.19	Taking the filtration pumps into operation	70
3.4	Initial commissioning	72
3.4.1	Checklist for commissioning	72
3.4.2	Stick the label (national language) onto the locking device of the MultiPort valve	73
3.4.3	Carrying out the install wizard	74
3.4.4	Preparing the Alyza IQ for measuring	76
4	Measurement / Operation	78
4.1	General operating principles	78
4.2	Measurement operation	79
4.2.1	Determination of measured values	79
4.2.2	Starting the measuring operation	79
4.2.3	Measuring	79
4.3	Settings for the Alyza IQ	80
4.3.1	IQ SENSORNET <i>Settings of sensors and diff. sensors</i>	80
4.3.2	Priority	83
4.3.3	<i>Damping</i>	84
4.4	Calibration	84
4.4.1	Overview	84
4.4.2	Calibration	85
4.4.3	Calibration history	88
4.4.4	Reactivating the last valid calibration	88
4.5	Information on the Alyza IQ	89
4.5.1	Information on the current operating condition (Tab <i>Status</i>)	89
4.5.2	Information on the expected lifetimes of replacement parts (tab <i>Remaining</i>)	90
4.5.3	Information on maintenance activities and calibration procedures (tab <i>History</i>)	92
4.5.4	More information on the Alyza IQ (tab <i>Info</i>)	95
4.6	Transferring information to a USB memory device via the	

Alyza IQ	95
4.6.1 Transferring to a USB memory device a selection of important operating data	96
4.6.2 Transferring detailed operating data to a USB memory device for evaluation by the service department	96
4.7 Software update for the Alyza IQ	97
5 Maintenance and cleaning	100
5.1 Hazard warnings	100
5.2 Opening the locking device of the MultiPort valve ("Before opening: Drain the system")	101
5.3 Replacement parts, accessories	105
5.4 Overview of the maintenance and cleaning activities	107
5.5 Installing / exchanging the ChemBags, MPV, tubes	109
5.5.1 Start the maintenance routine of the Alyza IQ	110
5.5.2 Prepare the maintenance activities	111
5.5.3 Open the measuring unit	111
5.5.4 Installing the MultiPort valve (MPV) and tubes	113
5.5.5 Remove the ChemBags for maintenance activities	116
5.5.6 Check the collection tray under the ChemBags for liquids	117
5.5.7 Installing the ChemBags	119
5.5.8 Terminating the maintenance routine	122
5.6 Changing the measuring range	122
5.7 Cleaning the sample filtration and sample feed	123
5.7.1 Mechanical cleaning of the filter plate	123
5.7.2 Chemical cleaning of the filter plate	124
5.7.3 Storing a used and cleaned filter plate	126
5.7.4 Replacing the filter plate of the sample filtration	127
5.7.5 Cleaning the sample feed, overflow vessel and outlet	128
5.8 Maintenance activities at the housing	134
5.8.1 Cleaning the housing of the Alyza IQ	134
5.8.2 Changing the filter mats	134
5.8.3 Checking the temperature control	136
5.9 Maintenance activities at the power supply box	137
5.10 Emptying the system manually	142
5.11 SystemCheck	145
6 Maintenance and cleaning (complex activities)	147
6.1 Decommissioning	147
6.1.1 Preparing the decommissioning	147

6.1.2	Decommissioning the measuring unit	149
6.1.3	Decommissioning for transport or storage	152
6.2	Complex maintenance- and cleaning activities in the measuring unit	152
6.2.1	Dismounting the measuring unit	153
6.2.2	Carrying out complex maintenance activities	154
6.2.3	Check the waste collector for coating	154
6.2.4	Installing the measuring unit	157
6.3	Transport, storage	158
6.3.1	General notes	158
6.3.2	Preparing the Alyza IQ for transport or storage	158
6.4	Recommissioning the Alyza IQ	161
7	What to do if ...	162
8	Technical data	168
8.1	Measuring characteristics <i>NH4-N / NH3-N, NH4</i>	168
8.2	Application conditions	169
8.3	General data	170
8.4	Electrical data	173
8.5	Consumption data	174
9	Lists	175
9.1	Explanation of the messages	175
9.1.1	Error messages	175
9.1.2	Informative messages	179
9.2	Status info	183
10	Disposal	184
11	Appendix	185
11.1	Glossary	185
12	Contact Information	187
12.1	Ordering & Technical Support	187
12.2	Service Information	187

1 Overview

1.1 How to use this component operating manual

Structure of the IQ SENSORNET operating manual

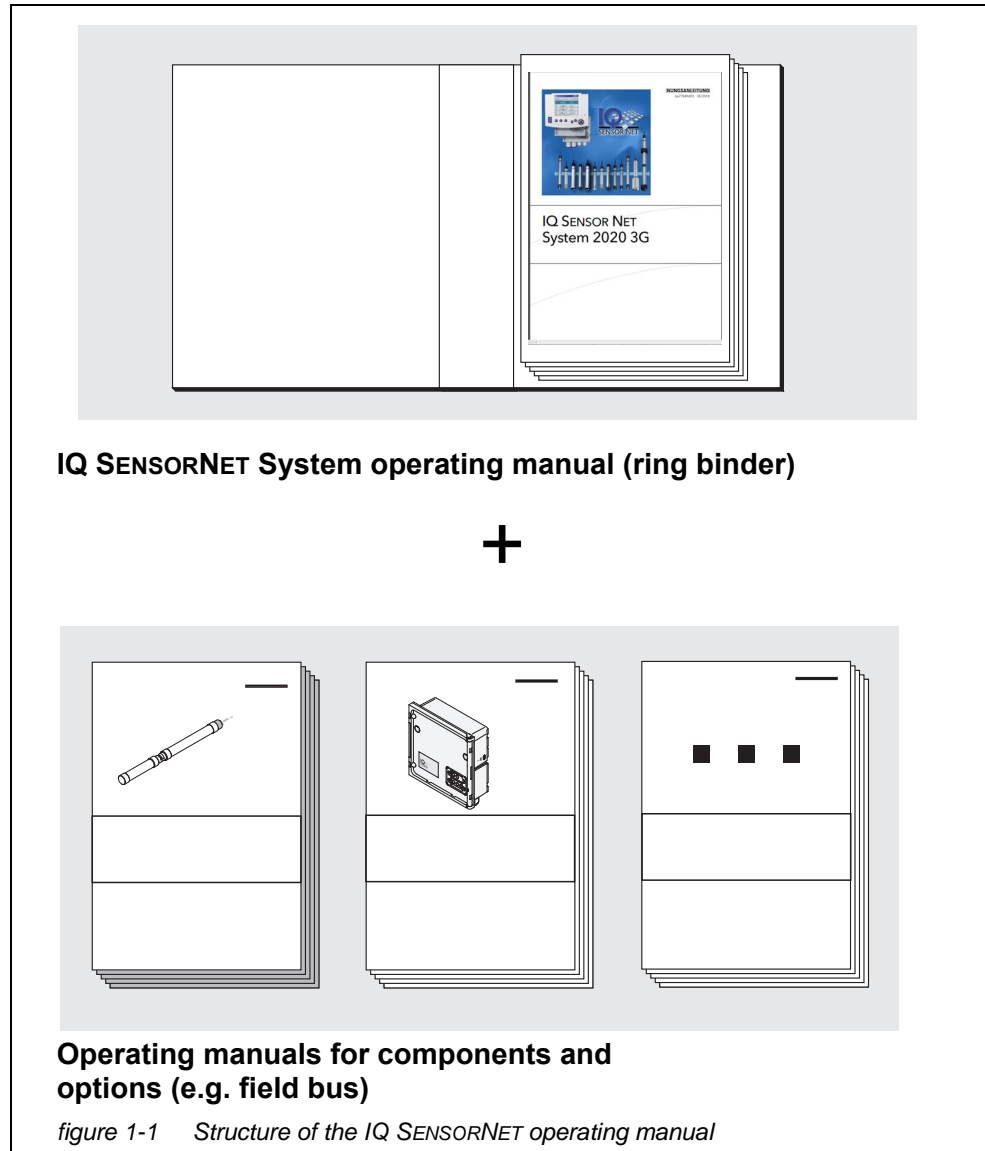

The IQ SENSORNET operating manual has a modular structure like the IQ SENSORNET system itself. It consists of a system operating manual and the operating manuals of all the components used. Please file this component operating manual into the ring binder of the system operating manual.

1.2 Metrological basics NH4-N / NH3-N, NH4

Ammonium In aqueous solutions, ammonia (NH₃) and ammonium (NH₄⁺) are at equilibrium (NH₃ + H₂O → NH₄⁺ + OH⁻). In acidic solutions (pH value < 7) there are more ammonium ions, in alkaline solutions (pH value > 7) there is more ammonia.

Measuring method The analyzer Alyza IQ NH4 measures the concentration of ammonium ions in an aqueous solution. By adding reagents to the sample, first the ammonium ions present are converted into ammonia, which then reacts further in the presence of hypochlorite ions to form monochloramine. In further steps, the monochloramine formed reacts with a phenol derivative with the aid of a catalyst to form the desired dye, which is measured photometrically at a suitable wavelength. The method detects both ammonium ions and ammonia. Both are linked via the pH value of the sample.

Citation forms The ammonium concentration is quoted in milligrams per liter (mg/l). The value can either refer to the total ammonium or only to the nitrogen atom contained therein. The values can be converted as follows:

- 1 mg N = 1.2879 mg NH₄ = 1.2159 mg NH₃
- 1 mg NH₄ = 0.7765 mg NH₄-N
- 1 mg NH₃ = 0.8224 mg NH₃-N

Concentration values referring to the nitrogen atom are indicated by the addition NH₄-N (citation form).

1.3 Product description

1.3.1 Overview

Application Analyzers of the Alyza IQ series are designed for online measurements in aqueous samples.

Variant	Measurement
Alyza IQ NH4	Ammonium measurements e.g. for regulation of the aeration control in biological activated sludge tanks in waste water treatment plants Measurements in the final effluents of waste water treatment plants Measurements for water body and river monitoring

Measurement takes place photometrically, at adjustable intervals, including automatic sampling (sample filtration and sample feed).

Measuring system Analyzers of the Alyza IQ series are operated as "sensors" in the

IQ SENSORNET.

The following components are required for operation of the Alyza IQ:

Component / function	Explanation
Sensor	The Alyza IQ analyzer is an IQ SENSORNET sensor with special functions.
Controller, terminal connection module	<p>For controlling, and to display the measured values, the Alyza IQ requires a functioning IQ SENSORNET system.</p> <p>Examples of simple IQ SENSORNET systems (minimum configuration):</p> <ul style="list-style-type: none"> ● IQ SENSORNET system (2 components): <ul style="list-style-type: none"> – 1 terminal/controller (e.g. MIQ/TC 2020 3G) for operation and display of measured values – 1 module (e.g. MIQ/JB) to establish the connection between the terminal/controller and sensor ● IQ SENSORNET system (1 component): <ul style="list-style-type: none"> – DIQ/S 28X
Mounting	<p>The Alyza IQ must be safely mounted for operation. The following mounting variants are available:</p> <ul style="list-style-type: none"> ● Wall mounting assembly (WM) ● Railing support mounting (RM) ● Mounting stand (SM)
<p>Sample filtration, sampling</p> <ul style="list-style-type: none"> ● Sample feed ● Sample filtration ● Lines for the transport of liquids, with heat tracing 	<p>Alyza IQ variant with filtration pumps (1 or 2) to feed the sample to the Alyza IQ or The sample is externally taken and made available inside the Alyza IQ.</p> <p>Filtration module (FM/PC) with frame and filter plate</p> <p>Lines with heat tracing for 1 x or 2 x intake line (SH - ...), 1 x return line (RH - ...) and, if necessary, 1 x return line (RH - ...) for the separate disposal of chemical waste from the measuring unit</p>

Instrument design fig. 1-2, 10 shows the main components of the Alyza IQ.

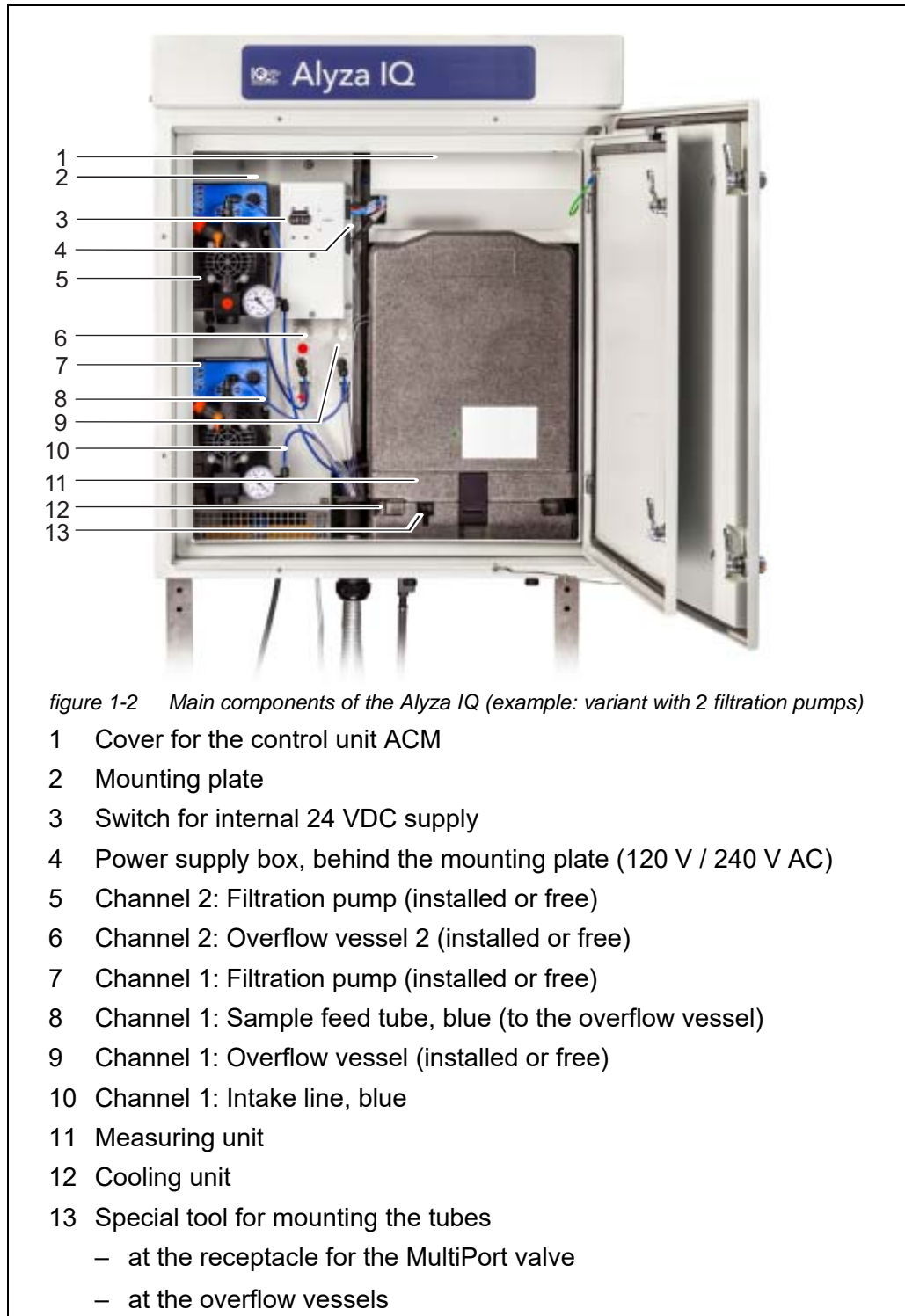

The measuring unit ready for operation (11) includes the following components

- Front cover with light duct for the status LED of the measuring unit
- Control unit (ACS)
- Locking device of the MultiPort valve (MPV)
- MultiPort valve (MPV)
- Photometer unit
- Chemicals (ChemBags)

Temperature control

For correct measurements, the operating temperature of the Alyza IQ is controlled inside the housing in the following areas.

Range	Temperature control
Housing inside	frost free
Measuring unit	20 °C (68 °F)
Photometer unit	45 °C (113 °F)

Thus the Alyza IQ with the door closed is suitable for all-season operation in the open. The temperature control is automatically active when the Alyza IQ is connected to the power supply and the switch at the switch box is in the ON position.



Where there is a chance of frost, the intake lines and return lines must be provided with heat tracing in order to maintain the sample feed.

Power supply and communication

fig. 1-3, 12 shows the power supply and communication interfaces of the Alyza IQ.

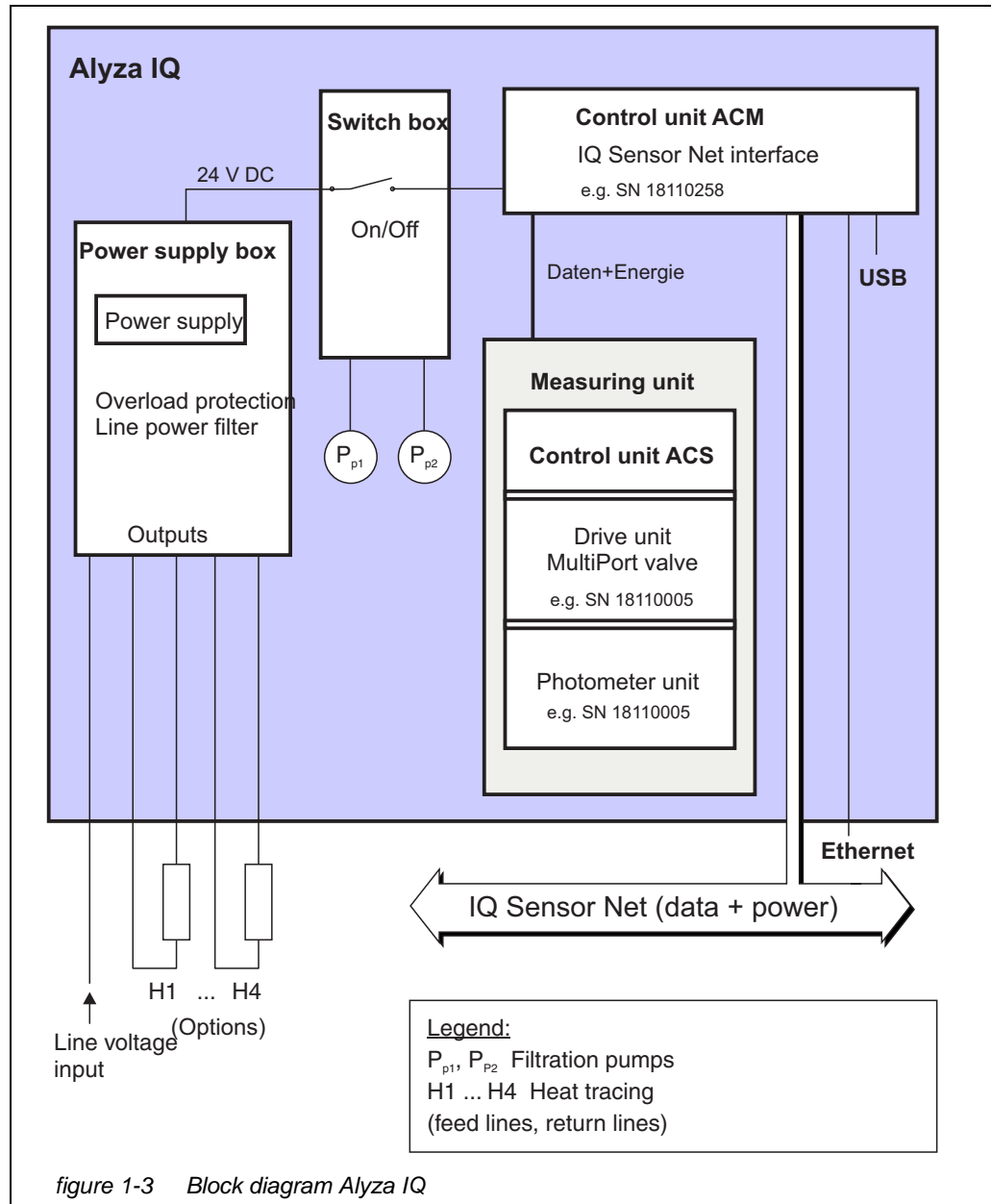

Operation The Alyza IQ is connected to the IQ SENSORNET via the IQ SENSORNET cable (SNCIQ) connected to the control unit ACM and conducted to the outside. The Alyza IQ is operated with a terminal on the IQ SENSORNET. If maintenance activities are being carried out on the open Alyza IQ, a terminal for operation must be installed or docked in the vicinity of the Alyza IQ.



Information on IQ SENSORNET terminals is given in the relevant IQ SENSORNET system operating manual.

Liquid circle fig. 1-4, 13 shows the liquid circle of the Alyza IQ.

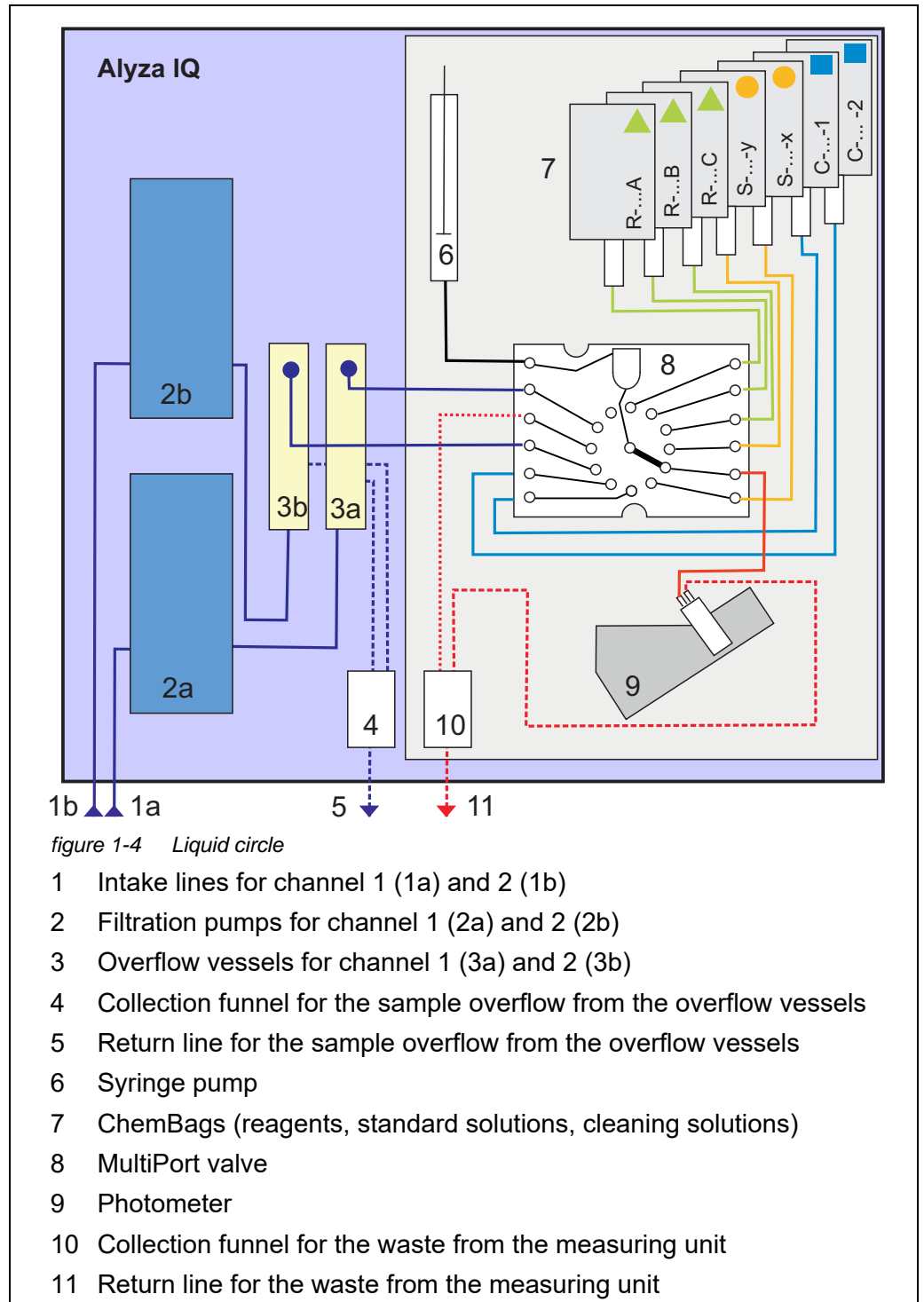

1.3.2 Measuring unit

fig. 1-5, 14 shows the open measuring unit (without front cover).

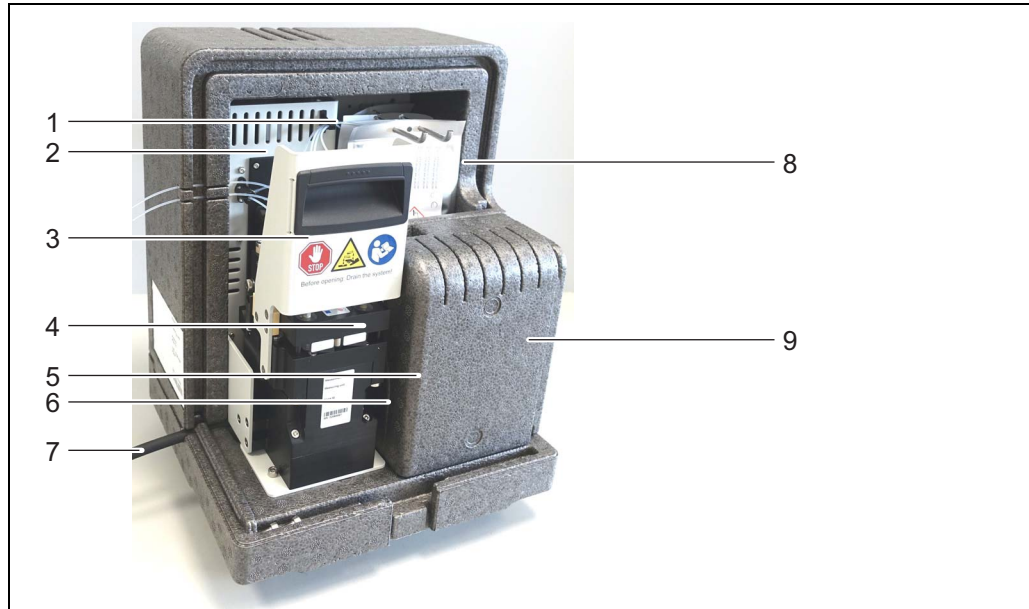

figure 1-5 Open measuring unit (without front cover)

- 1 Tube fastening
- 2 Control unit ACS
- 3 Locking device of the MultiPort valve (MPV)
- 4 Receptacle for the MultiPort Valve (MPV) with tubes
- 5 Contact that detects whether the measuring unit is closed with the front cover.
(If there is the risk of condensation of air humidity in an open measuring unit, a warning is triggered.)
- 6 Status LED of the measuring unit
(The status of the status LED is visible through a light duct at the outside of the front cover.)
- 7 Waste tube of the measuring unit
- 8 ChemBags, suspended from two supporting rods
- 9 Photometer unit

How it functions

The measuring unit is controlled and supplied with DC voltage by the control unit ACM. Communication with the IQ SENSORNET takes place via the IQ SENSORNET cable, as with all other sensors.

In the overflow vessel, sample that is fresh, filtrated, and nearly free of air bubbles is quasi continuously provided for the measurements. The filtration unit (FM/PC - available as an accessory) in conjunction with the filtration pump (instrument variant) provides an optimally prepared sample.

A syringe pump in the measuring unit makes all the liquids move (sample, reagents, standard solutions, cleaning solutions).

The MultiPort Valve (4) runs each of the moving liquids to the place where they

are required. The dosing of the reagents to the sample takes place in the mixing chamber in the MultiPort valve.
The sample mixed with reagents is then moved to the cell in the photometer unit (9) to be measured.

fig. 1-5, 14 shows the open photometer unit (without front cover).

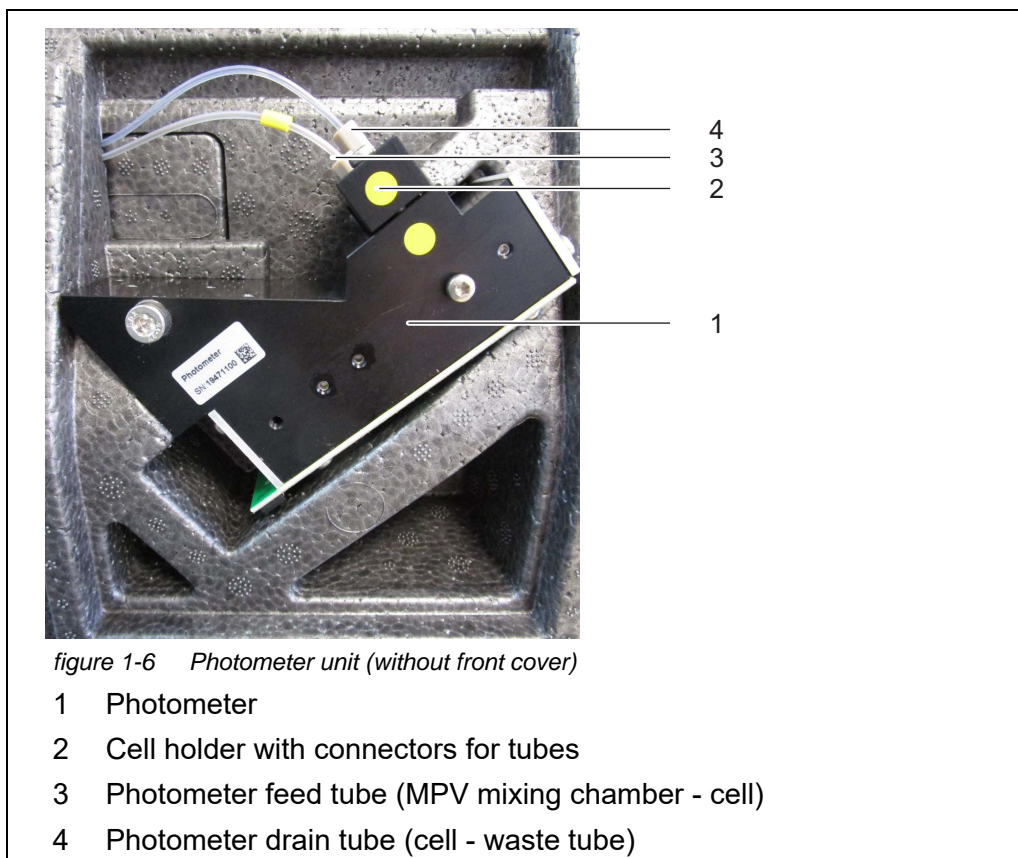

figure 1-6 Photometer unit (without front cover)

- 1 Photometer
- 2 Cell holder with connectors for tubes
- 3 Photometer feed tube (MPV mixing chamber - cell)
- 4 Photometer drain tube (cell - waste tube)

The photometer unit has an LED as the light source and a photo diode as the detector. After the measurement, the liquid is removed from the photometer unit through the waste tube (4).

1.3.3 ChemBags

The Alyza IQ has an extra counter for each liquid container. The counter counts the consumption of the following procedures as soon as the function is started:

- Measuring
- Calibration
- Cleaning

Other procedures that consume liquids are not counted (e.g. *Fill the system*).



The current counter reading for the ChemBags can be viewed in the Alyza menu (tab *Remaining*).
 In the overview, the remaining time is displayed in days (*Days*).
 You can display more details for each ChemBag with **<OK>**.

If the remaining time of a ChemBag is less than 30 days, a log book message is automatically generated.



Attention: The remaining times are only correct if the date of expiry was correctly entered.

Special bags (ChemBags) are used as liquid containers in the Alyza IQ. To guarantee the shelf life of the liquids (reagents, standard solutions, cleaning solutions) the ChemBags are coated with aluminium and encase the chemicals airtight.
 The ChemBags are suspended from two supporting rods with the valves pointing downward.

Installing (even for the first time) and replacing the ChemBags are maintenance activities, carried out at and documented menu-guided by the Alyza IQ.
 Replace the ChemBags before the liquids are used up.



Keep the original caps of the ChemBags. They can be screwed on for disposal.









1.3.4 Status LEDs

The status LEDs indicate the statuses of the components:

Status-LED at the filtration pump

LED	Meaning
Off	No power supply
Green	The filtration pump is ready to operate and waiting for the next action.
Red	The filtration pump is making a pump movement.

Status LED at the front cover of the measuring unit

LED		Meaning
Off		No power supply
Red		Error The Alyza IQ is stopped, details see log book
Red, flashes quickly (in addition, a beep is to be heard)		Close the front cover of the measuring unit immediately. Risk of damage due to the formation of condensation water on electronic components within the measuring unit. If the measuring unit is opened for longer than 3 minutes, the Alyza IQ is automatically stopped to avoid damage due to condensation.
Green		The measuring unit is in one of the following states: <ul style="list-style-type: none"> – Ready for operation, waiting for the next action – Getting ready for operation (booting up)
Green, flashes slowly		The measuring unit carries out an action e.g. Measuring, calibrating, cleaning
Blue		The Alyza IQ was stopped manually (by the user). The measuring unit is not (yet) ready to be opened.
Blue, flashing		The control unit ACS starts.
White		The Alyza IQ was stopped manually (by the user). The measuring unit is ready to be opened.
White, flashing		The Alyza IQ was stopped manually (by the user). The locking device of the MultiPort valve is ready to be opened.

1.3.5 Instrument variants

The Alyza IQ analyzer is available in different versions. The variant is given in the type designation on the name plate.

Structure of the name plate

Alyza IQ NH4-XYZ

figure 1-7 Structure of the type designation

- 1 **X**: Measurement procedure
- 2 **Y**: Measuring range
- 3 **Z**: Number of channels

Type designation (details)

Identifier	Values	Variant
X (Variant: measuring procedure)	1	Photometric measurement (Berthelot method)
Y (Variant: measuring range)	1	Measuring range The measuring range (low or high concentration) can be changed by exchanging the ChemBags according to the user guide.
Z (Variant sample channels)		Sample channels (number) (Z = 0, 1, 2, depending on the variant of the Alyza IQ) Each sample channel enables to provide sample from one source. For each sample channel, extra components are required (e.g. filtration pump, overflow vessel). The number of sample channels can be adapted.
	0	The test sample has to be provided for the measurement by external sampling. Please heed the requirements of the sample.
	1	The test sample is automatically fed from a source and provided for the measurement.
	2	The test sample is automatically fed from two sources and provided for the measurement.
3	115	Input voltage 115 V AC



It is possible to retrofit a variant to a different variant (identifier Y, Z) by installing or dismantling components (contact the service department).

**Filtration pumps
(instrument variants:
1 channel or
2 channels)**

The filtration pump is optimally adjusted to the sample filtration available as an accessory.
fig. 1-8, 19 shows a filtration pump in the Alyza IQ.

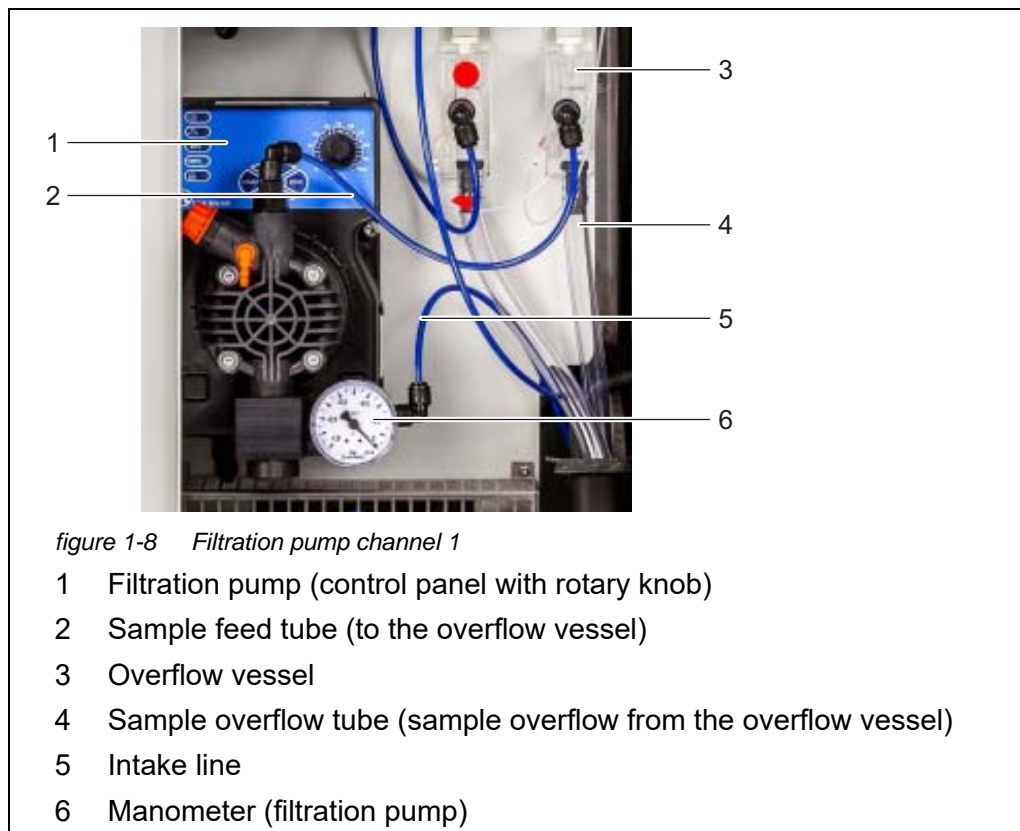

The filtration pump quasi continuously draws sample through the intake line (5) and pumps it into the overflow vessel (3) through the sample feed tube (2). The flow rate can be set with the control knob on the control panel (1). On the intake side, a manometer (6) is installed for low pressure measurement.

To provide sample liquid with the required quality, it is necessary to use a suitable sample filtration (available as an accessory).

1.3.6 Sample filtration



The sample filtration must prepare the sample so that the sample quality meets the requirements of the measuring unit (see section 8.2 Application conditions, 169).

To separate the particles in the sample, the preassembled filter module FM/PC is available as an accessory. It is connected to the Alyza IQ via an intake line. The filtration pump in the Alyza IQ draws in the filtered sample.

The preassembled filter module (FM/PC) consists of a separable PVC frame (FM Case/PC) and a filter plate (Filter/PC). With the aid of the M 1.5 basin attachment for filtration, the FM filter module FM/PC can be immersed in the measuring medium and can be adjusted in height. To clean the filter plate, the filter

unit can be pulled out along a guide rail with a chain.
 The intake line is in a robust sleeve tube. Intake lines are available in different lengths and with auxiliary heating to protect against frost (depending on the line voltage).

fig. 1-9, 20 shows an application example in a sedimentation tank.

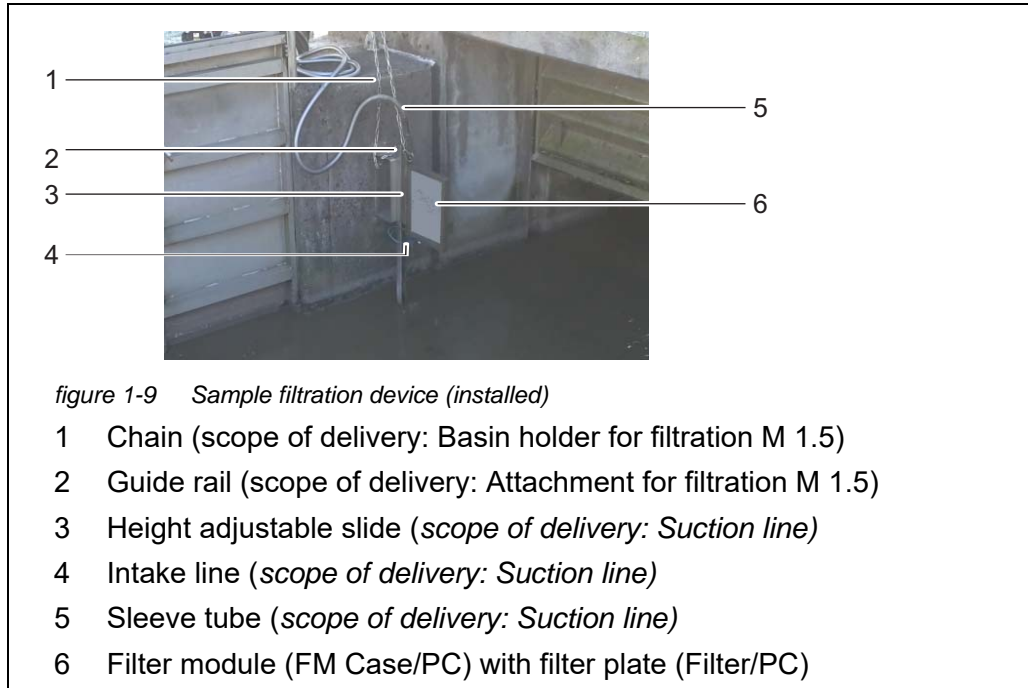

The return lines transport the liquids collected in the collection funnel (sample from the overflow vessels and the liquid chemical waste from the measuring unit) out of the housing. Return lines with heat tracing are available for frost protection.



Order information on accessory items:
 see section 5.3 Replacement parts, accessories, 105

1.4 Name plates

The following components have name plates:

Component	Place of the name plate
Alyza IQ basic instrument	center, on the left-hand inside housing wall
Measuring unit	outside, on the left rear side of the measuring unit and on the front of the MPV drive unit
Photometer	at the photometer

Component	Place of the name plate
MultiPort valve (MPV)	on the side of the MPV
Mounting plate	on the right-hand side of the switch box
Sleeve tubes of the intake lines and return lines	at the end of the line (toward the Alyza IQ)



Keep the series numbers on the name plates ready for any service requests.

The serial numbers of the following components can also be queried via the Alyza menu, tab *Info*:

- *Ser. no. MIQ/Alyza (housing/ACM)*
- *Ser. no. Alyza IQ (measuring unit/ACS)*
- *Ser. no. of photometer*
- *Ser. no. MultiPort Valve (MPV)*

2 Safety instructions

2.1 Safety information

2.1.1 Safety information in the operating manual

This operating manual provides important information on the safe operation of the product. Read this operating manual thoroughly and make yourself familiar with the product before putting it into operation or working with it. The operating manual must be kept in the vicinity of the product so you can always find the information you need.

Important safety instructions are highlighted in this operating manual. They are indicated by the warning symbol (triangle) in the left column. The signal word (e.g. "CAUTION") indicates the level of danger:

**WARNING**

indicates a possibly dangerous situation that can lead to serious (irreversible) injury or death if the safety instruction is not followed.

**CAUTION**

indicates a possibly dangerous situation that can lead to slight (reversible) injury if the safety instruction is not followed.

NOTE

indicates a situation where goods might be damaged if the actions mentioned are not taken.

2.1.2 Safety signs on the product

Note all labels, information signs and safety symbols on the product. A warning symbol (triangle) without text refers to safety information in this operating manual.

2.1.3 Further documents providing safety information

The following documents provide additional information, which you should observe for your safety when working with the measuring system:

- Operating manuals of other components of the IQ SENSORNET system (power packs, controller, accessories)
- Labels on the chemical containers (ChemBags)
- Safety datasheets of calibration and maintenance equipment (e.g. cleaning solutions). Safety datasheets provide security relevant information on hazardous materials and mixtures. Carefully read the safety datasheets and follow all instructions. We recommend that you store all datasheets in one folder.

2.2 Safe operation

2.2.1 Authorized use

The authorized use of the Alyza IQ is its use as a sensor in the IQ SENSORNET. Only the operation and running of the Alyza IQ according to the instructions and technical specifications given in this operating manual is authorized (see chapter 8 Technical data, 168). Any other use is considered unauthorized.

With unauthorized use, the protection type supported by the instrument can be adversely affected.

2.2.2 Requirements for safe operation

Note the following points for safe operation:

- The product may only be operated according to the authorized use specified above.
- The product may only be operated under the environmental conditions mentioned in this operating manual.
- The product may only be supplied with power by the energy sources mentioned in this operating manual.
- The product may only be opened if this is explicitly described in this operating manual (example: connecting electrical lines to the terminal strip).

2.2.3 Unauthorized use

The product must not be put into operation if:

- it is visibly damaged (e.g. after being transported)
- it was stored under adverse conditions for a lengthy period of time (storing conditions, see chapter 8 Technical data, 168).

2.3 User qualification

Target group

The IQ SENSORNET system was developed for online analysis. Some maintenance activities, such as exchanging the ChemBags or tubes, require the safe handling of chemicals. Thus, we assume that the maintenance personnel is familiar with the necessary precautions to take when dealing with chemicals as a result of their professional training and experience.

Special user qualifications

The following installation activities may only be performed by a qualified electrician:

- Connecting power cables to the line power supply and the line power box.
- Connecting the heat tracing lines to the connectors of the line power box

2.4 Personal protective equipment (PPE)

The PPE includes clothing and other equipment that is used to protect you against risks at your place of work. You must always wear your PPE while doing dangerous jobs to avoid injuries or damage to your health.

The following table shows the PPE that is required while dealing with dangerous chemicals such as when exchanging the ChemBags. More detailed information is given on the labels of the ChemBags and in the relevant safety data sheets.





Personal protective equipment	Typical examples
Protective clothing with long sleeves	
Protective goggles	
Chemical resistant gloves	
Safety shoes	

figure 2-1 Personal protective equipment



It is the duty of the operator to provide all users with the required PPE. The PPE must fulfill the national standards and laws.

3 Commissioning

3.1 IQ SENSORNET system requirements

Software versions of the controller and terminal components

The operation of the Alyza IQ requires the following software versions in the IQ SENSORNET:

MIQ/MC2	Version 3.79 or higher
MIQ/TC 2020 XT	Version 3.79 or higher
MIQ/MC3	Version 3.79 or higher
MIQ/TC 2020 3G	Version 3.79 or higher
DIQ/S 28X	Version 3.79 or higher

3.2 Scope of delivery

3.2.1 Scope of delivery of the Alyza IQ

The following parts are included in the scope of delivery of the Alyza IQ:

- Housing (Alyza IQ NH4-XYZ) with
 - mounted and wired installations
 - mounted power cable (approx. 2 m)
 - mounted IQ SENSORNET cable (approx. 2 m)
- Key for outer housing door
- Switch cabinet key for interior door
- Cover plate for the control unit ACM
- Bug screen (mounting set)
- Collection funnel (mounting set)
- MultiPort valve (MPV)
- Labels in the national language (for the locking device of the MultiPort valve)
- 1 tube
 - to connect the ChemBag for cleaning solution 2 to the MPV (cleaning of deposits in the cell, the tubes, in the waste collector). The installation of cleaning solution 2 is recommended for:
 - Measuring range 1 (MR1)
 - Measuring range 2 (MR2), for measuring media with a total hardness > 1.3 mmol/l (7.3 °dH)
- Operating manual

Check whether the scope of delivery is complete before starting the installation.

3.2.2 Accessories required in addition

Depending on the application, the following additional accessories are required or recommended for operation. We explicitly recommend that you use original accessories:

- | | |
|--|--|
| Mounting accessories | The mounting accessories are used to securely install the instrument at the mounting location.
The following variants are available: <ul style="list-style-type: none"> ● Rail mount RM ● Wall mount WM ● Stand mount SM |
| Mount for a terminal | <ul style="list-style-type: none"> ● Mount TM for fastening and operation of an MIQ module, e.g. MIQ/JB and terminal/controller MIQ/TC 2020 3G or DIQ/S 28X |
| ChemBags | Depending on the type, variant and configuration of your Alyza IQ, you need one or several ChemBags for each of the following options: <ul style="list-style-type: none"> ● Reagent solution (R-...) suitable for measured parameter and measuring range ● Standard solution (S-...) suitable for the measured parameter, measuring range, and calibration procedure ● Reagent solution (C-...) suitable for measured parameter and measuring range |
| MultiPort valve | <ul style="list-style-type: none"> ● MultiPort valve (MPV) |
| Sample preparation (filtration) | <ul style="list-style-type: none"> ● Filter module FM/PC (frame FM Case/PC incl. preassembled filter plate Filter/PC) |
| | <div style="display: flex; align-items: flex-start; margin-top: 10px;"> <div style="margin-right: 10px;"></div> <div>The sample filtration must prepare the sample so that the sample quality meets the requirements of the measuring unit (see section 8.2 Application conditions, 169).</div> </div> |
| | <ul style="list-style-type: none"> ● Basin holder for filtration M 1.5 for frame FM Case/PC, also available with extension M-EXT 1.5 |
| Sample inlet, sample drain | <ul style="list-style-type: none"> ● Intake line SH ... (different lengths up to 20 m, with and without heat tracing [240 VAC or 120 VAC]) ● Return line RH ... (different lengths up to 20 m, with and without heat tracing [240 VAC or 120 VAC]) |



Order information referring to accessories is given in section 5.3 Replacement parts, accessories, [105](#).

3.3 Basic principles of installation

3.3.1 Requirements of the measurement location

The measurement location must meet the environmental conditions specified in section 8.3 General data,  170.

Controlled ambient conditions

Work on the open instrument (e.g. during mounting, installation, maintenance) may only be carried out under controlled environmental conditions:

Temperature range	+ 5 ... + 40 °C (+ 41 ... +104 °F)
Relative air humidity	≤ 80 %

If the Alyza IQ is already in operation, the temperature of the measuring unit must be adapted to the ambient temperature prior to opening the measuring unit. The temperature adaptation is done with the function *Prepare to open measuring unit*. As soon as the measuring unit is ready to be opened, this is displayed in the *Status* tab. The status LED of the measuring unit lights up white.

NOTE

The interior of the measuring unit is temperature-controlled to 20 °C (68 °F). With ambient temperatures over 25 °C (77 °F) and high air humidity, condensation water may develop on the cool surfaces and cause damage when the measuring unit is opened.

*To avoid damage of the measuring unit due to the formation of condensation water, always wait for the temperature adjustment (function *Prepare to open measuring unit*) to be completed before opening the measuring unit.*

3.3.2 Safety requirements of the electrical installation

The safety of the system into which the instrument is integrated is the responsibility of the builder of the system.

Electrical equipment (e.g. motors, contactors, cables, lines, relays, switches, instruments) must meet the following requirements:

- Compliance with national regulations (e.g. NEC, VDE and IEC)
- Suitability for the electrical conditions at the place of installation
 - Maximum operational voltage
 - Maximum operational current
- Suitability for the ambient conditions at the place of installation
 - Temperature resistance (minimum and maximum temperature)
 - Stability against UV light in the case of outdoor usage
 - Protection against water and dust (Nema or IP type of protection).
- Suitable fuse protection of the electrical circuit

- Overcurrent protection devices
(according to the technical data of the instrument input or output)
- Overvoltage class II surge limiters
- Suitable disconnecting device (e.g. switch or circuit breaker) for the line power supply of permanently mounted equipment with separate line power connection,
 - labeled as disconnecting device for this instrument
 - compliant with the following regulations
 - IEC 60947-1
 - IEC 60947-3
 - in the vicinity of the instrument (recommendation)
- Fault current protection switch (ground fault circuit interrupter) especially with operation of heat tracings
- Flame resistant (cable and lines), compliant with the following regulations
 - UL 2556 VW-1 (for USA, Canada)
 - IEC 60332-1-2 (outside of USA, Canada)



Details on the conditions at the installation site:
See chapter 8 Technical data, [168](#).

3.3.3 General installation instructions



This section describes the installation of the Alyza IQ with various, especially designed accessories. We assume that the operator uses these accessories. In this section, the individual scopes of delivery are not distinguished so the comprehensibility of the operating manual is not affected.

Pay attention to the following points during installation:

- The measuring device is shipped in protective transport packaging.
We recommend: Keep the packaging material.
The original packaging protects the measuring device from transport damage
- Due to its weight, the Alyza IQ always has to be carried by two people (housing door upward, both people grasping the housing at the upper C rail and at the housing bottom on the side of the door).
- Wear safety shoes for transport, installation and mounting work (see section 2.4 Personal protective equipment (PPE), [24](#)).
- Installation in the open should be done while the weather is frost-free (environmental conditions, see section 3.3.1 Requirements of the measurement location, [27](#)).

- Mount the Alyza IQ in a straight position (check, for example, with a water level) to ensure that the liquids can drain off optimally.
- Mount the Alyza IQ so that the space under the housing bottom is always free for ventilation of the housing.
- Mount the Alyza IQ at a suitable height so that the liquids in the return lines (into the basin) can freely drain off at a steady slope.
- The Alyza IQ may only be fastened on a wall or fixture with the aid of the two C-rails (housing upright).
- For mounting work, only use the mounting accessories included in the scope of delivery (screws, washers, springs, nuts). This ensures the safe fastening at the mounting location.

Main steps Installation of the Alyza IQ includes the following main steps:

- 1 Installing the housing (see section 3.3.4 Installing the housing, [§ 30](#)).
- 2 Removing the transport protection of the measuring unit (see section 3.3.8 Removing the transport protection of the measuring unit, [§ 42](#)).
- 3 Connecting the cables to the control unit ACM (see section 3.3.9 Connecting the cables to the control unit ACM, [§ 43](#)).
- 4 Mounting the cover plate for the control unit ACM (see section 3.3.10 Mounting the cover plate for the control unit ACM, [§ 44](#)).
- 5 Installing the bug screen and condensate drain adapter (see section 3.3.11 Installing the bug screen and condensate drain adapter, [§ 45](#)).
- 6 With the relevant accessories:
Mounting the terminal holder (TM) (see section 3.3.12 Mounting the terminal holder (TM), [§ 47](#)).
- 7 Mounting the collection funnel (see section 3.3.14 Mounting the collection funnel, [§ 59](#)).
- 8 With the relevant accessories:
Installing the FM/PC filter module and M 1.5 basin holder for filtration (see section 3.3.16 Installing the FM/PC filter module and M 1.5 basin holder for filtration, [§ 64](#)).
- 9 With the relevant accessories:
Connecting the power cable and heat tracing lines (see section 3.3.13 Connecting the power cable and heat tracing lines, [§ 50](#)).
- 10 Setting up a connection with the IQ SENSORNET system (see section 3.3.18 Setting up a connection with the IQ SENSORNET system, [§ 69](#)).
- 11 Installing / exchanging the ChemBags, MPV, tubes (see section 5.5 Installing / exchanging the ChemBags, MPV, tubes, [§ 109](#)).

3.3.4 Installing the housing

The housing of the Alyza IQ can be installed in the following ways:

- On the SM stand mount (see section 3.3.5 Installation on the SM stand mount, 30).
- On a rail (see section 3.3.6 Installation on a rail, 35).
- On a wall (see section 3.3.7 Installation on a wall, 40).



In the housing there is a foam insert serving as a transport protection. Remove the foam insert once the installation of the housing has been completed.

3.3.5 Installation on the SM stand mount

Proceed as follows to install the housing on the stand mount:

Assembling the stand mount

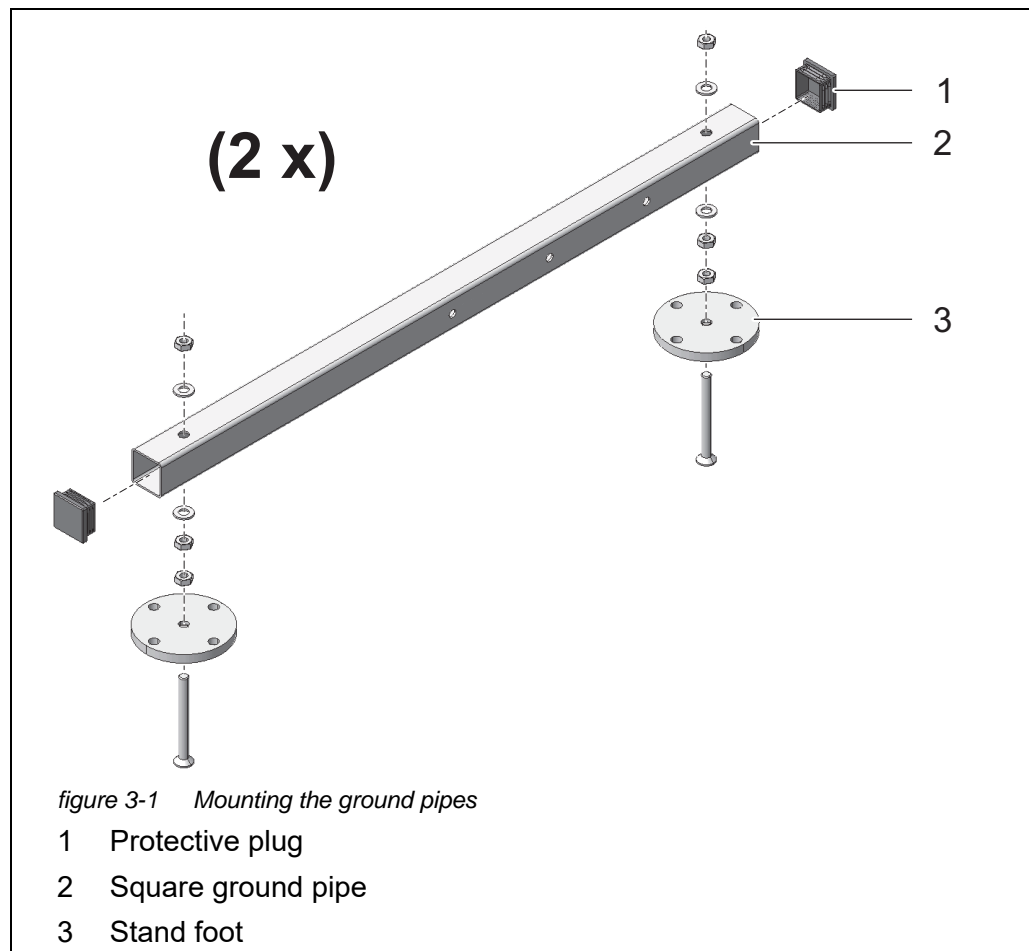

- 1 Press the plastic protective plugs (1) into both ends of the square ground pipes (2).

- 2 Mount the four height adjustable stand feet (3) on the square ground pipes (2) using the enclosed M10 hexagon countersunk head screws. Make sure to use the correct number of plain washers and nuts in the correct order according to fig. 3-1, 30.

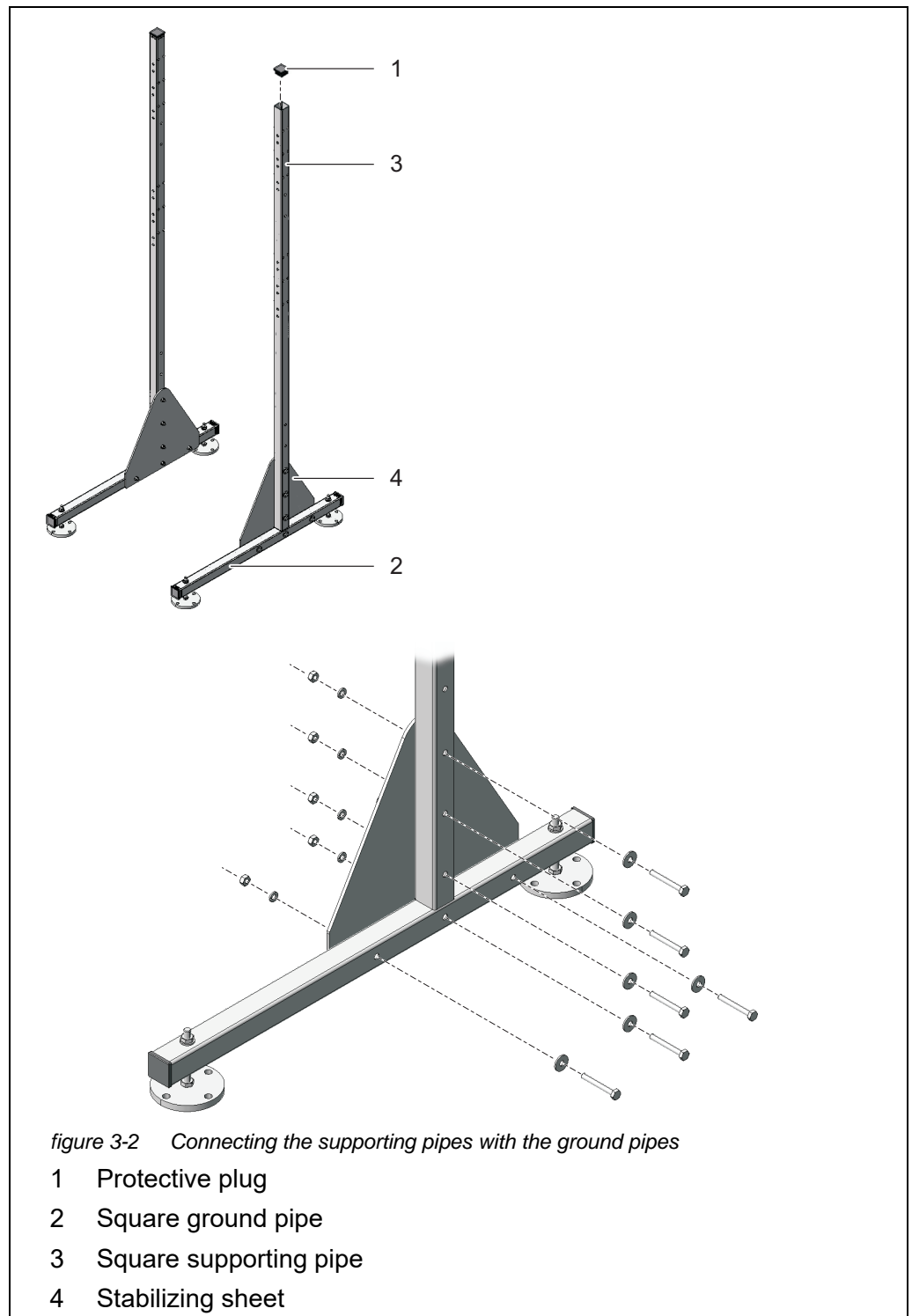

- 3 Press the plastic protective plugs (1) into the upper ends of both square supporting pipes (3).
- 4 Using the triangular stabilizing sheets (4), connect both square supporting pipes (3) with the preassembled ground pipes (2). For each side, use six hexagon head screws with large plain washers, spring washers and locknuts as shown in fig. 3-2, 31. Make sure the two sides mirror each other after being mounted.

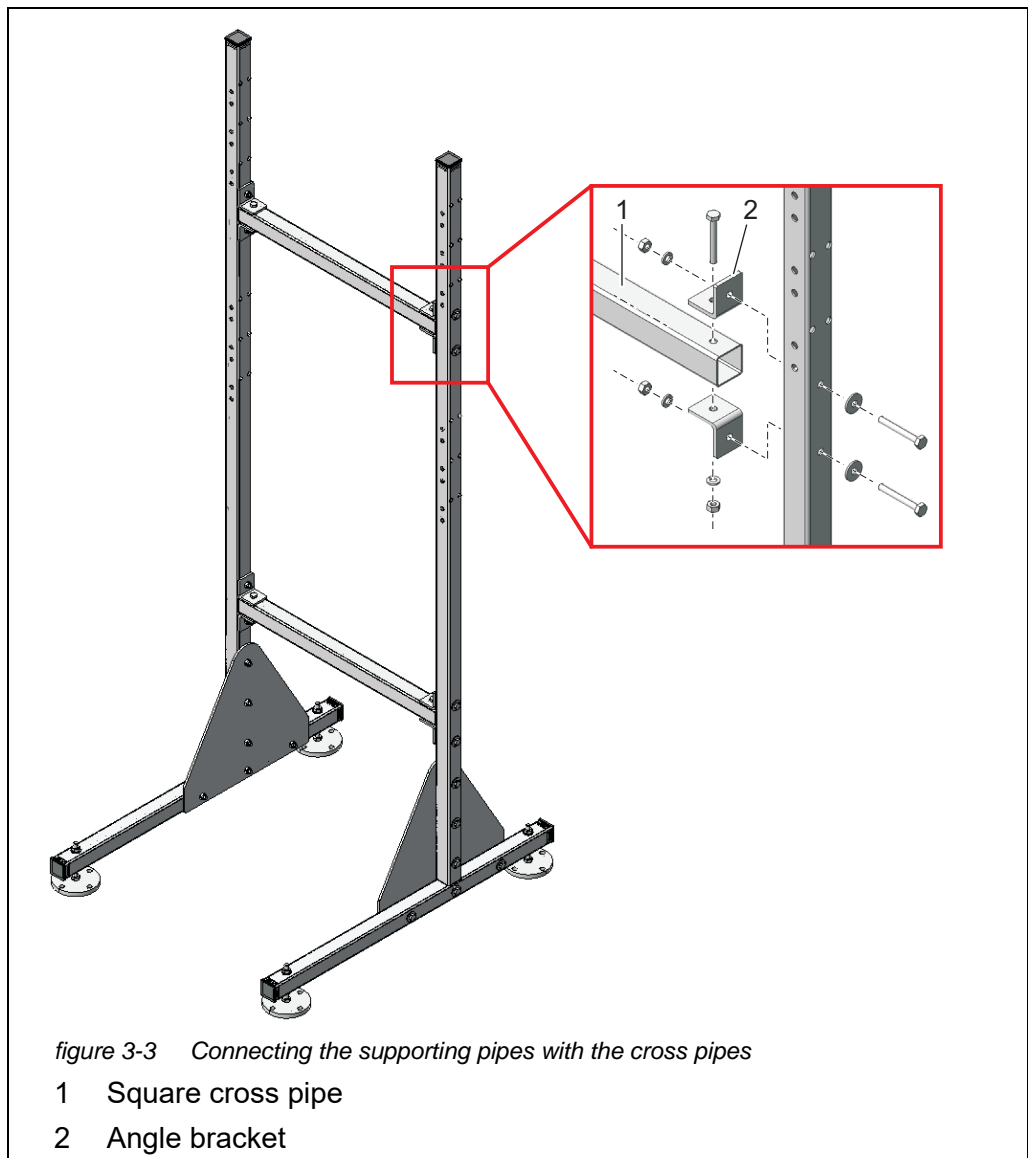

- 5 Connect both supporting pipes with each other using the two square cross pipes (1). For each joint, use two angle brackets (2), three hexagon head screws, two large plain washers, three spring washers and three locknuts.



Make sure that both triangular stabilizing sheets (5) are on the inside.

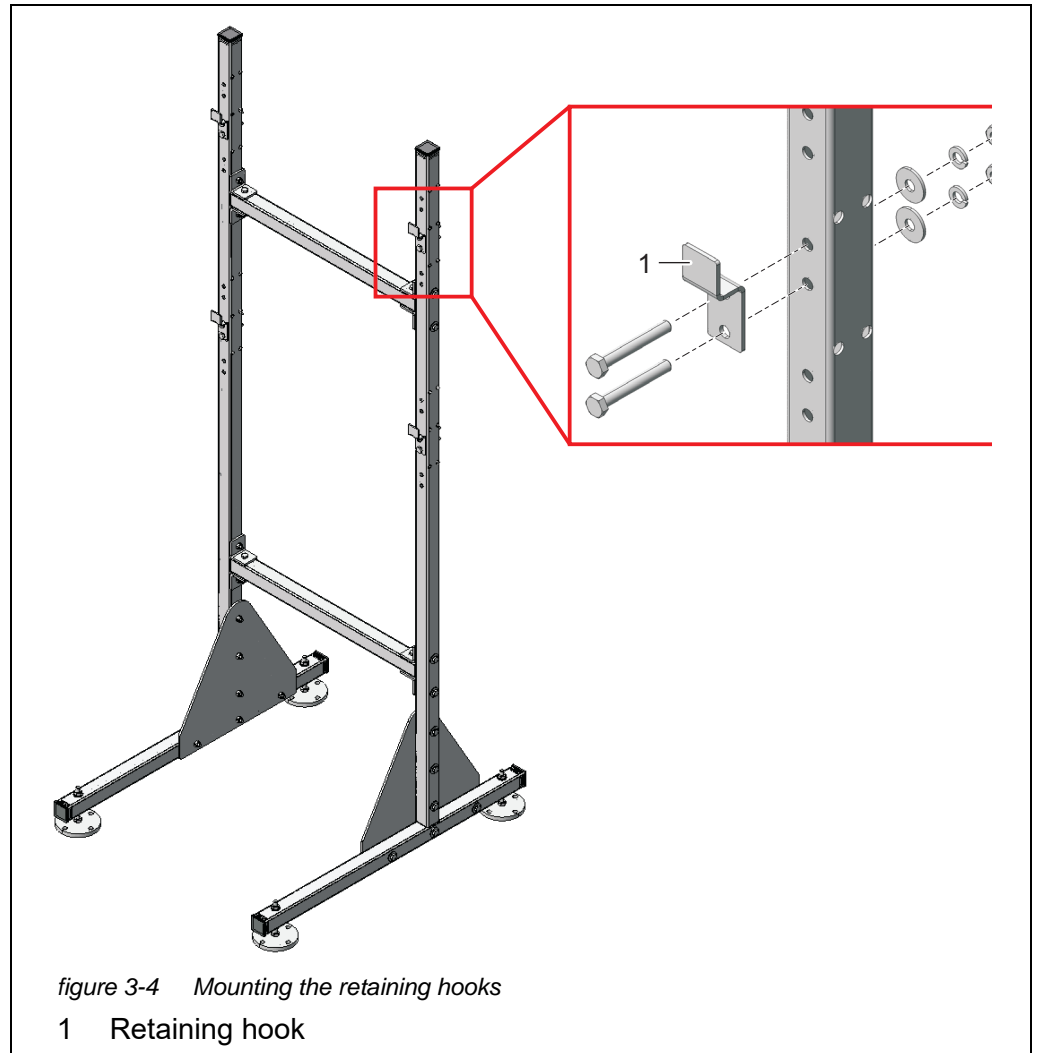

- 6 Mount the four retaining hooks (1) on the supporting pipes. For each hook, use two hexagon head screws, large plain washers, spring washers and locknuts.



On each side there are three pairs of holes for the upper and lower retaining hooks. Thus the Alyza IQ can be mounted optimally at working level. Use the same relative positions for each of the upper and lower hooks.

Positioning the stand mount

- 7 Place the stand mount at the intended operating location.

- 8 Adjust the four vertically adjustable stand feet in such a way that the mounting stand is in a straight position (check, for example, with a water level) to ensure that the liquids can drain off optimally.

NOTE

Always screw the four stand feet to the ground. If the instrument is mounted in the open, please make sure that the installation withstands even severe storm.

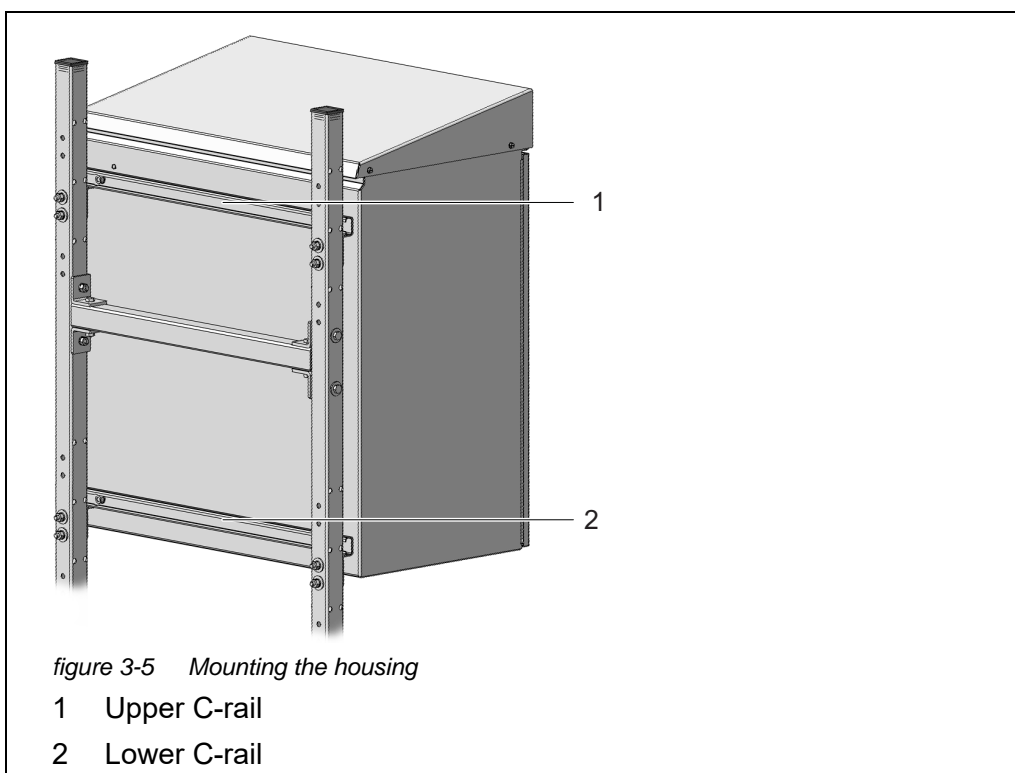
Mounting the housing

- 9 Mount the housing by hooking the C-rails (1 and 2) fixed on its rear side into the four retaining hooks of the stand mount.

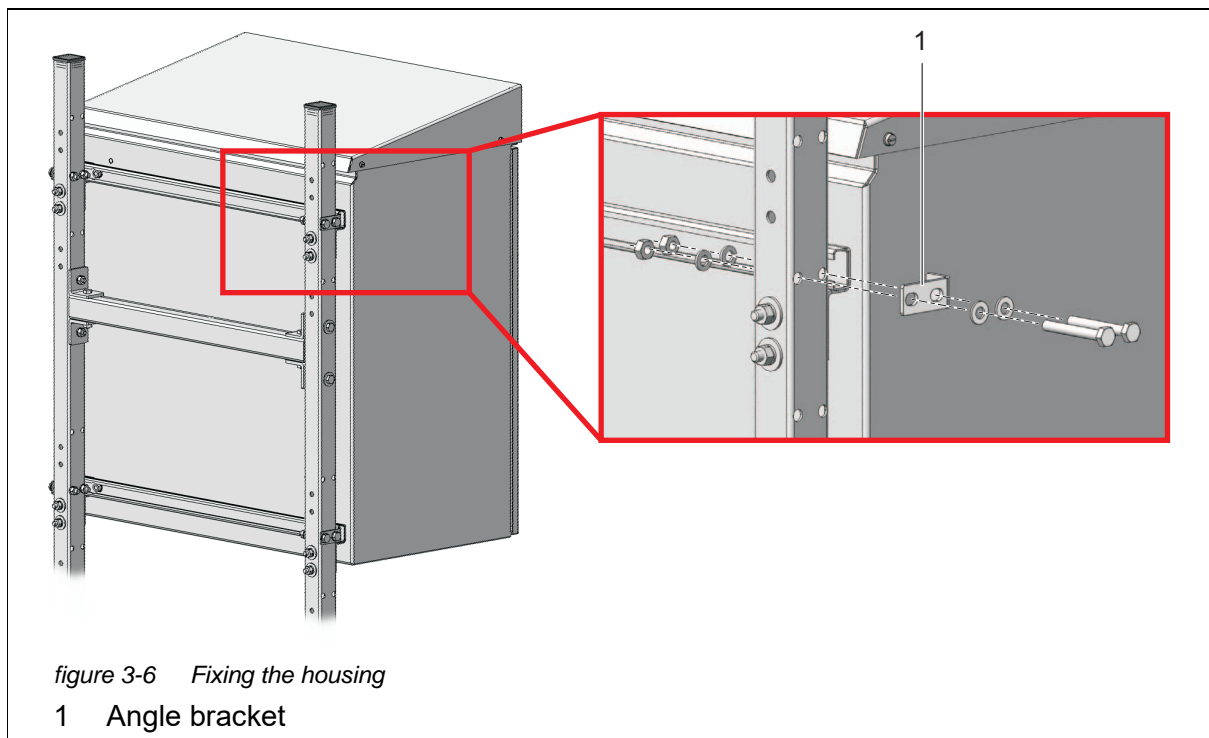

- 10 Fix the housing on both sides with four brackets (1) so it cannot shift sideways. For each bracket, use two hexagon head screws, small plain washers, spring washers and locknuts.

3.3.6 Installation on a rail

For installation on a rail, the RM rail mount bracket is required.

NOTE

Make sure that the rail is sufficiently stable. If the instrument is mounted in the open, please make sure that the installation withstands even severe storm.

Assembling the bracket

Proceed as follows to install the housing on the rail:

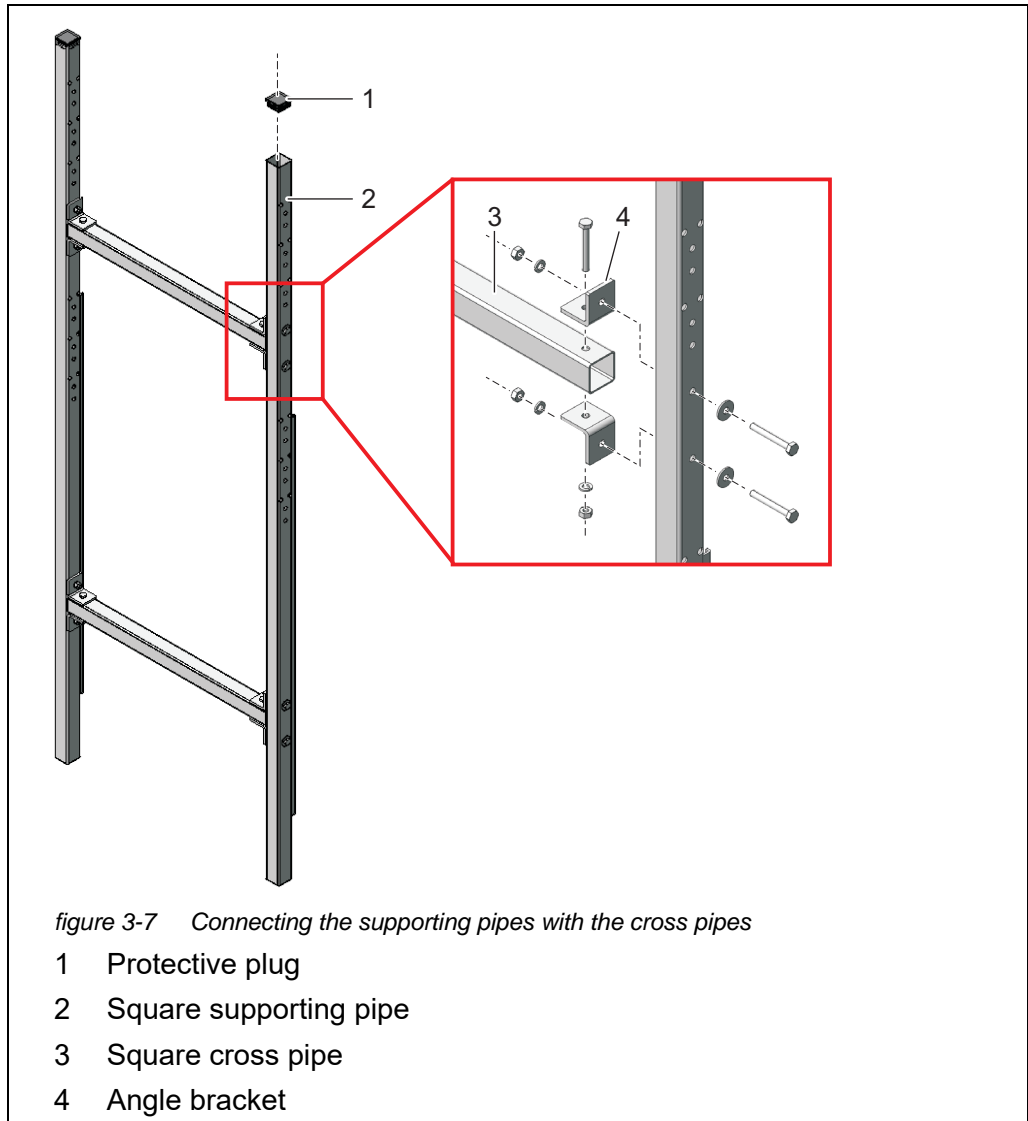

- 1 Press the plastic protective plugs (1) into the upper ends of both square supporting pipes (2).
- 2 Connect both supporting pipes with each other using the two square cross pipes (3). For each joint, use two angle brackets (4), three short hexagon head screws, two large plain washers, three spring washers and three locknuts as shown in fig. 3-7, 36.

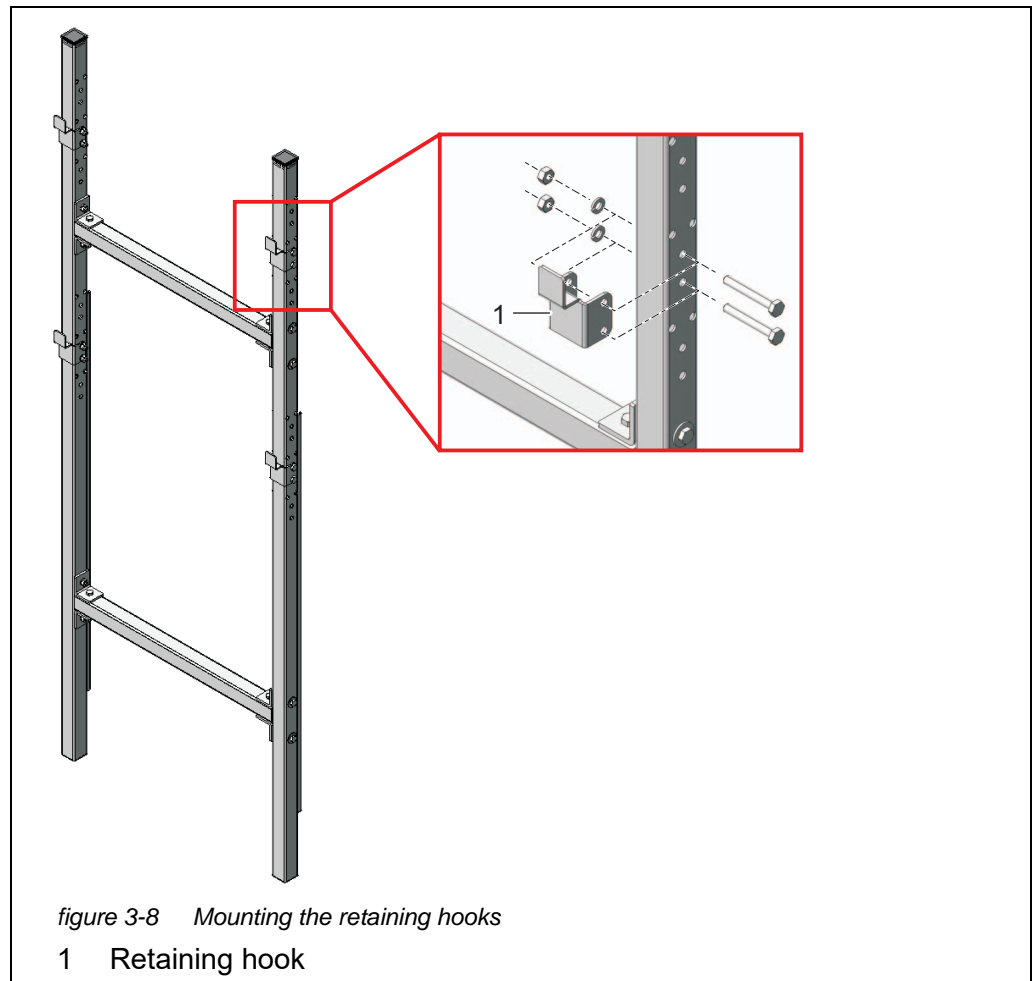

- 3 Mount the four retaining hooks (1) on the supporting pipes. For each hook, use two short hexagon head screws, spring washers and lock-nuts.



There are three pairs of holes each for the upper and lower retaining hooks. Thus the Alyza IQ can be mounted optimally at working level. Use the same relative positions for each of the upper and lower hooks.

Fixing the rail mount bracket

- 4 Place the rail mount bracket in front of the rail in the required position.

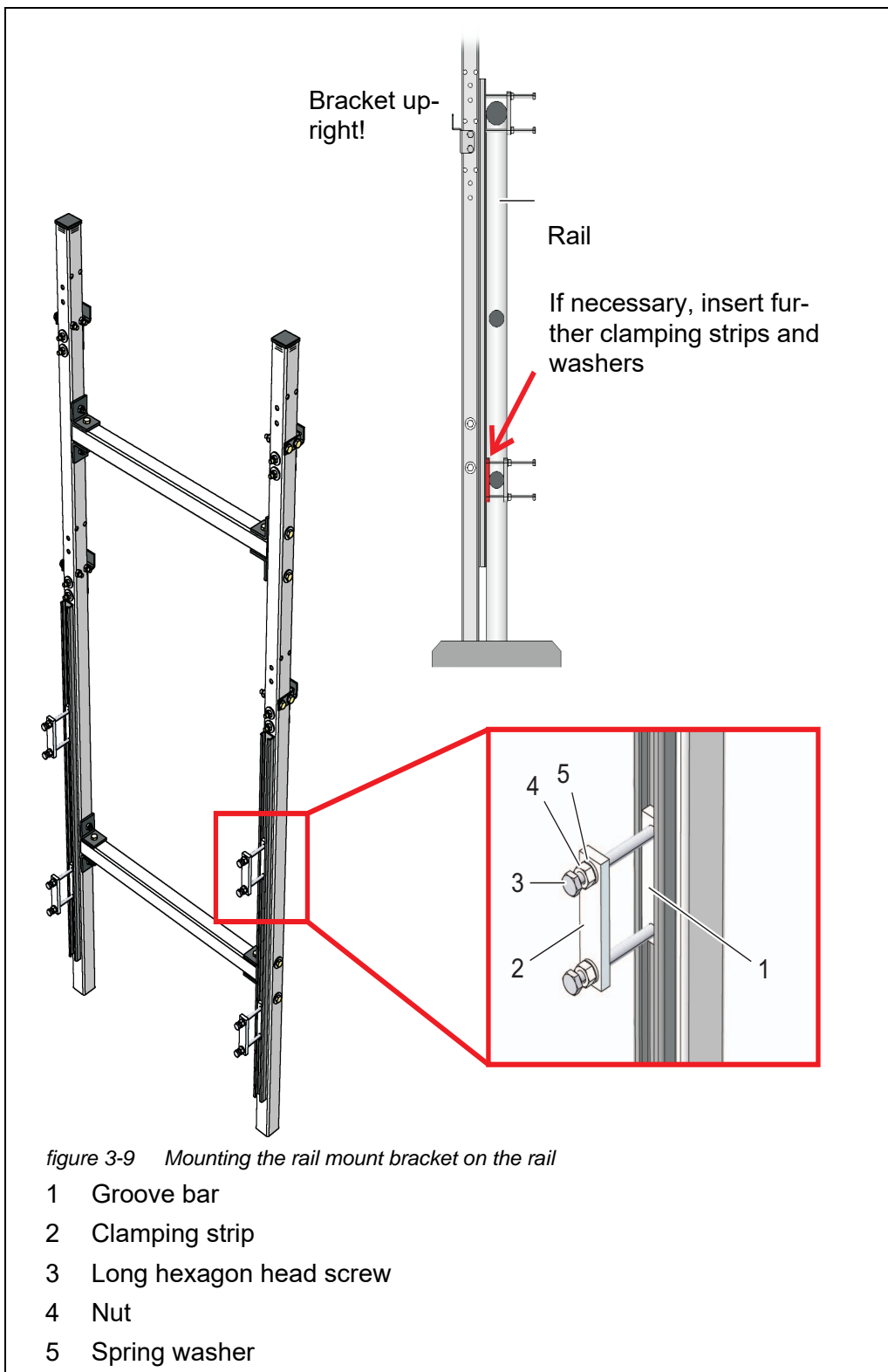

- 5 Attach the rail mount bracket to two suitable horizontal rail pipes with the aid of the four clamping devices. Each clamping device consists of a groove bar (1), a terminal strip (2), two long hexagon head screws (3), two nuts (4) and two spring washers (5). Adjust the clamping devices to the rail pipes. To compensate for any possible differences of the upper and lower rail pipe diameters, 2 further terminal strips and 8 washers (thickness 2 mm) are provided with the construction set. If necessary, insert these items between the rail and supporting pipes as shown in fig. 3-9, 38 so that the rail mount bracket is in a vertical position. Note that both supporting pipes must stand on the ground!



The weight of the Alyza IQ is supported by the rail mount bracket standing on the ground. The rail prevents the Alyza IQ from falling over.

Mounting the housing

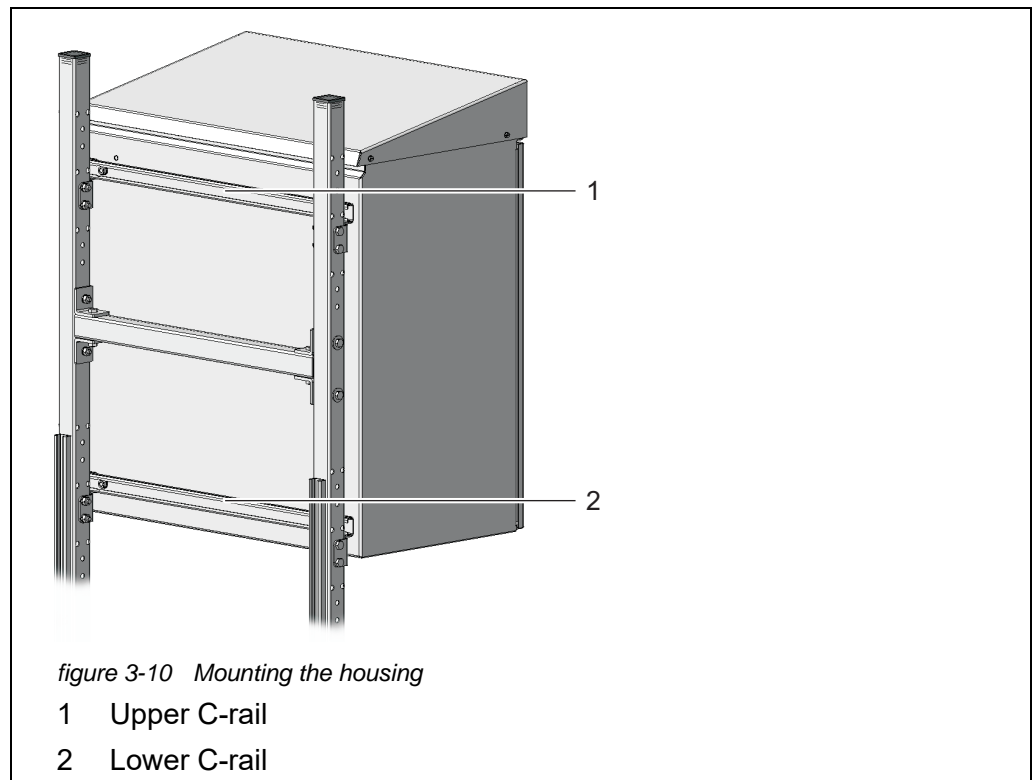

- 6 Mount the housing by hooking the C-rails (1 and 2) fixed on its rear side into the retaining hooks of the rail mount bracket.
- 7 Make sure that the housing is suspended in a straight position (check, for example, with a water level) to ensure that the liquids can drain off optimally in the Alyza IQ.

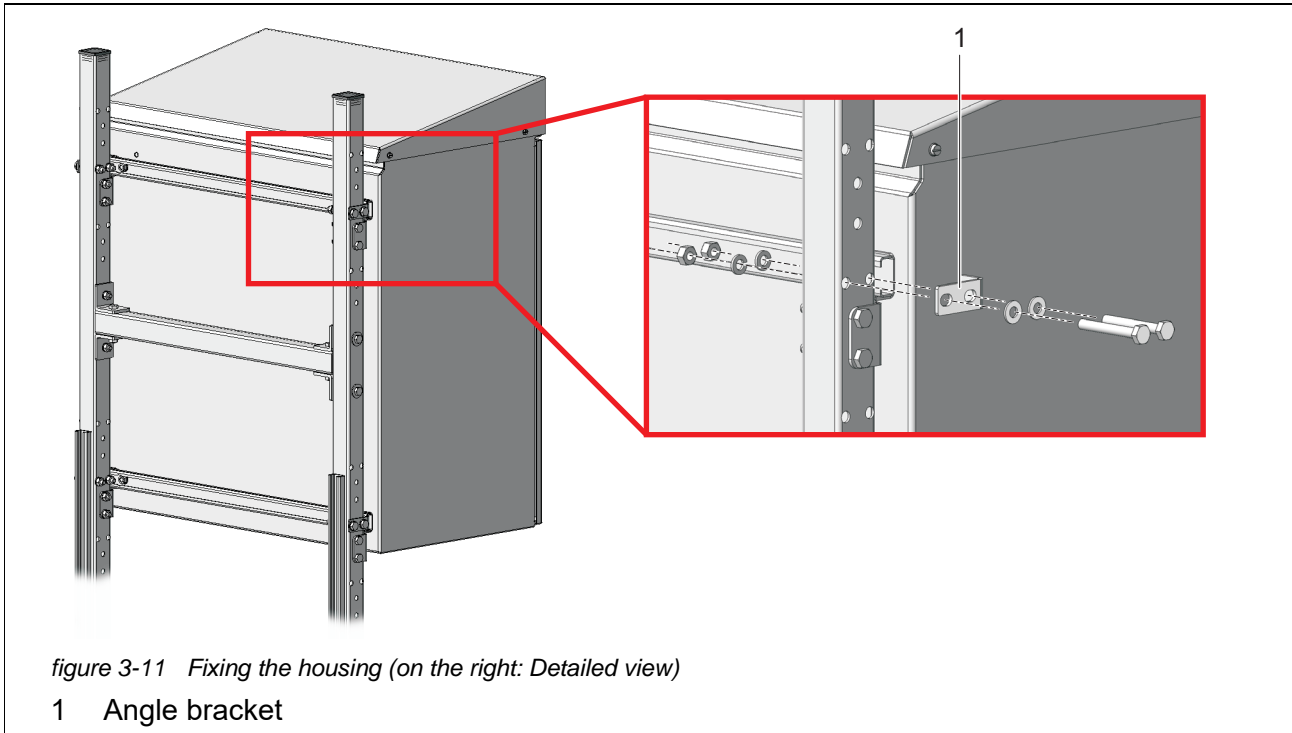

- 8 Fix the housing on both sides with four brackets (1) so it cannot shift sideways. For each bracket, use two short hexagon head screws, small plain washers, spring washers and locknuts.

3.3.7 Installation on a wall

With the C-rails on its rear side, the Alyza IQ is hooked into the retaining hooks of the WM wall mounting set.

NOTE

Make sure that the wall is strong enough for the weight of the Alyza IQ and that the mounting material (screws, plugs, etc.) is suitable for the wall type. If necessary, use other screws and plugs than the ones provided.

Proceed as follows to install the housing on a wall:

- 1 Drill eight holes as shown in the following figure:

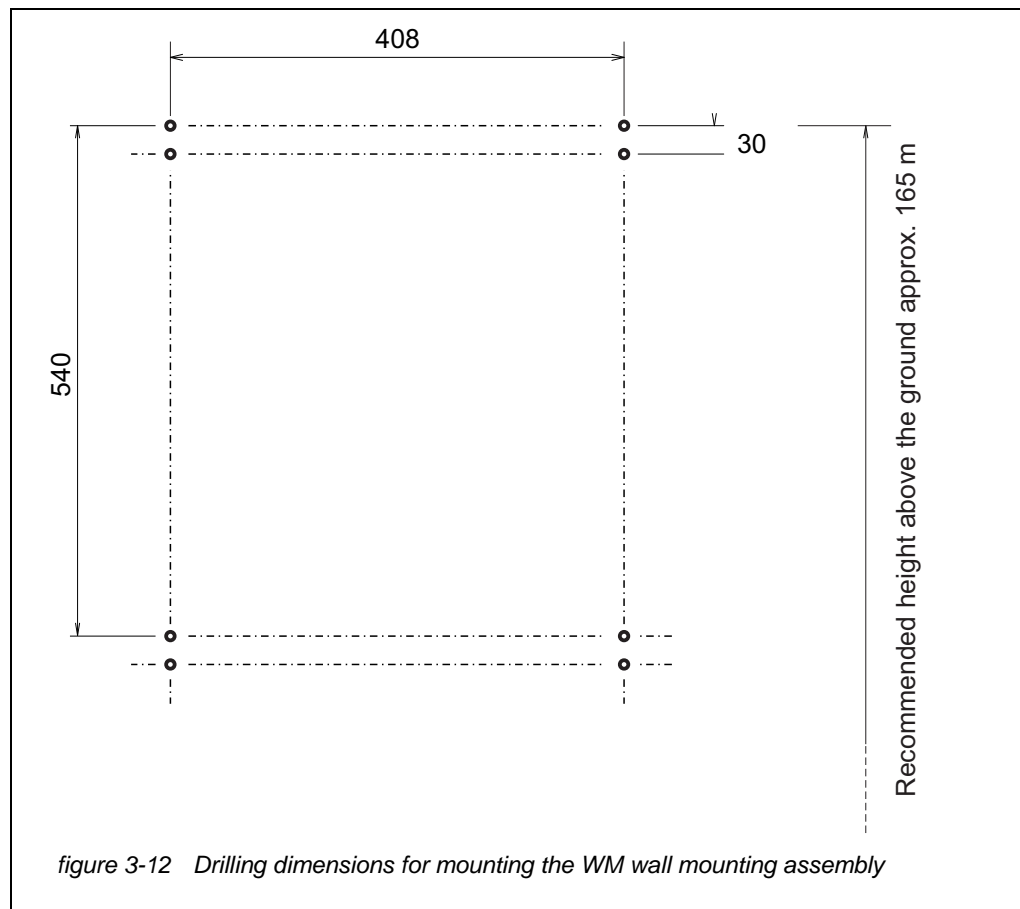

- 2 Screw tight the four retaining hooks of the wall mounting set.
- 3 Mount the housing by hooking the C-rails fixed on its rear side into the four retaining hooks.
- 4 Make sure that the housing is suspended in a straight position (check, for example, with a water level) to ensure that the liquids can drain off optimally in the Alyza IQ.

NOTE

To prevent the instrument from shifting laterally, the fixing screws of the C-rails have to be outside the retaining hooks on both sides (see fig. 3-13, 42.)

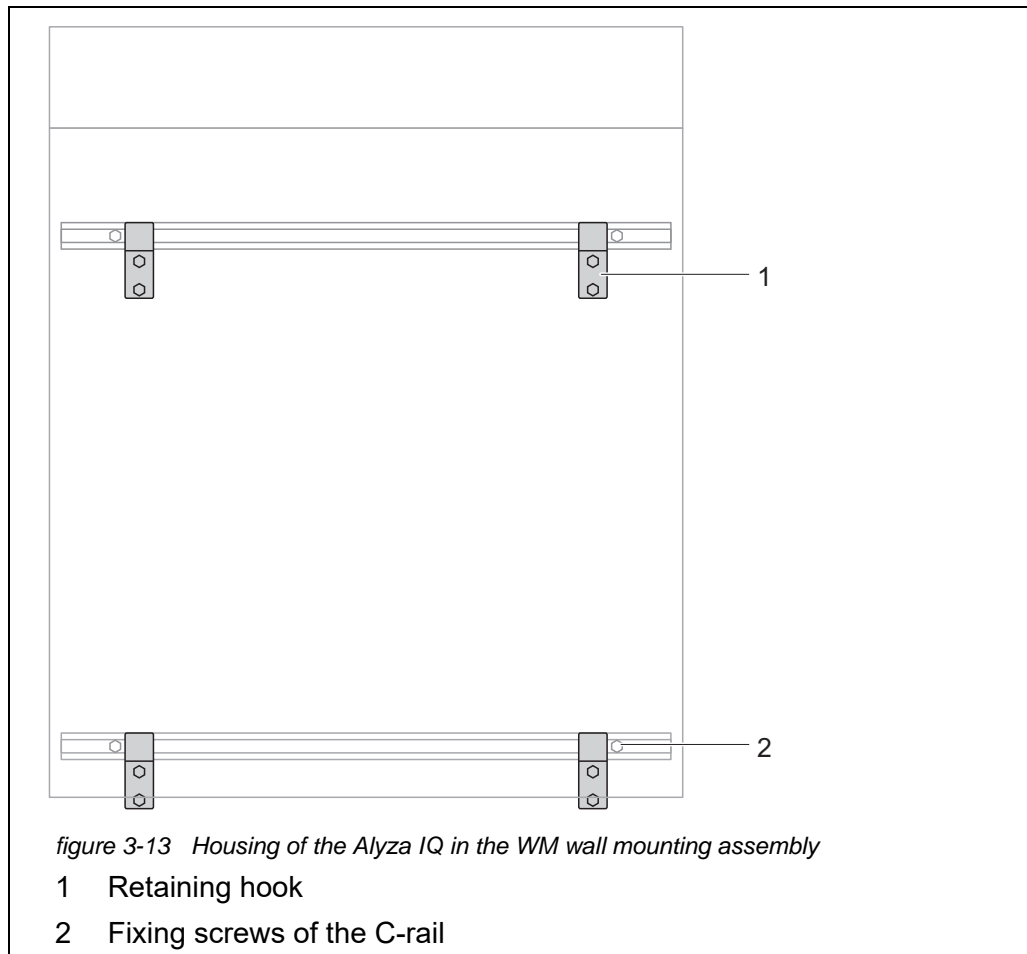

3.3.8 Removing the transport protection of the measuring unit

The transport protection in the housing of the Alyza IQ fixes the measuring unit in its position with the aid of 3 spacers made of foam.

- 1 Open the outer housing door far enough so the arrestable brake-stay catches.
- 2 Open the inner housing door far enough so that it touches the outer door. Tilt the angular sheet (at the inside of the outer door) over the upper edge of the inside door.
3 foam transport protectors are in the area between the control unit (1) and the measuring unit (5).

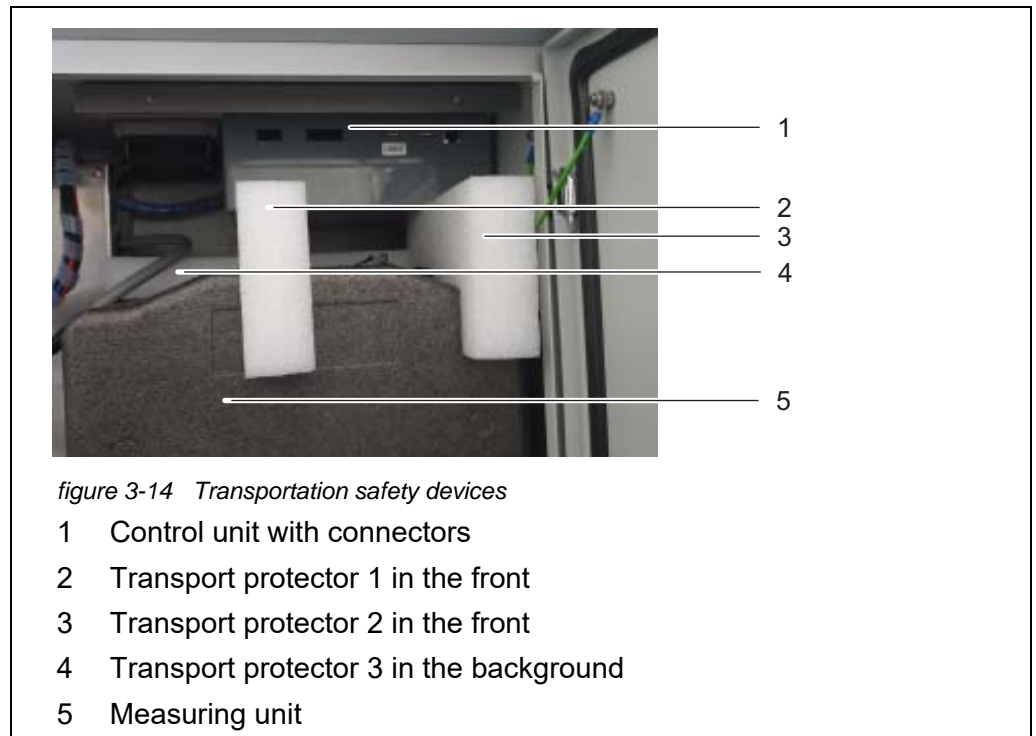

- 3 Pull the two transport protectors (2, 3) out to the front.
- 4 Carefully move the transport protector (4) of the measuring unit (5) upward and then pull it out to the front. The third transport protector is behind the transport protectors already removed.
- 5 Keep all transport protectors.
- 6 To transport the instrument, always use the transport protectors.

3.3.9 Connecting the cables to the control unit ACM

- 1 Remove the transport protection of the measuring unit (see section 3.3.8 Removing the transport protection of the measuring unit, [42](#)).
4 cable ends to be connected to the control unit are on the measuring unit.
- 2 Connect the 4 cables to the sockets of the control unit ACM. Connect the USB cable to the unlabeled USB connector (the connector labeled "USB0" remains free).
All other plugs will only fit into one socket in the correct direction.

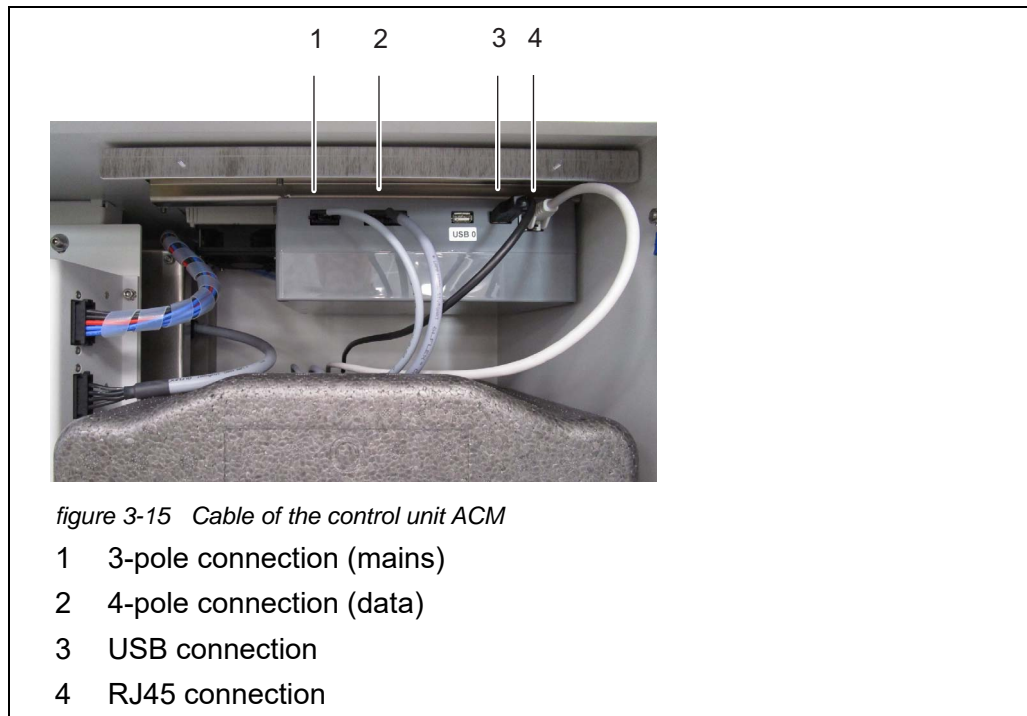

3.3.10 Mounting the cover plate for the control unit ACM

The cover plate for the control unit ACM covers the control unit ACM and the cables connected to it.

- 1 Remove the transport protection of the measuring unit (see section 3.3.8 Removing the transport protection of the measuring unit, 42).
4 cable ends are on the measuring unit.
- 2 Connect the 4 cables lying on the measuring unit to the control unit (see section 3.3.9 Connecting the cables to the control unit ACM, 43).
- 3 Unscrew the 2 knurled-head screws from the top hat rail on the housing top,
- 4 Screw the cover plate to the top hat rail with the 2 knurled-head screws.

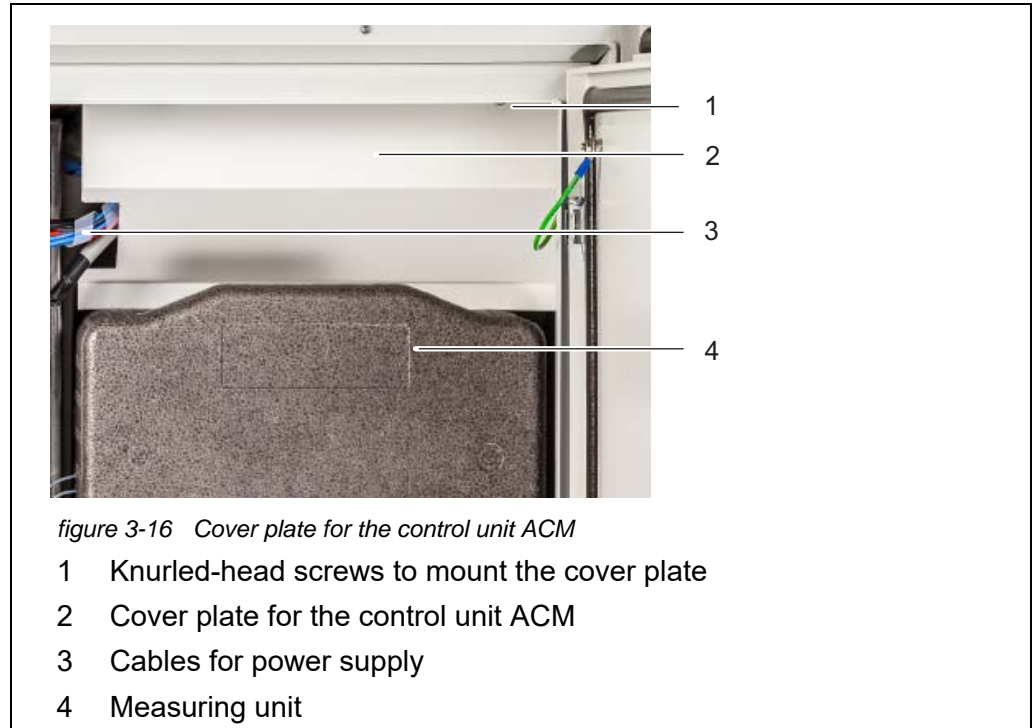

3.3.11 Installing the bug screen and condensate drain adapter

Bug screen The bug screen protects the interior of the Alyza IQ against insects coming in through the air intake opening in the bottom of the housing.

Condensate drain When the Alyza IQ is operated with local temperatures from approx. 25 °C (77 °F) and high moisture, water may condensate within the cooling unit. The condensate drain adapter runs the condensate that has formed to the outside. Parts of the condensate collect at the housing bottom and at the cooling unit. This condensation water formed during operation does not adversely affect the operation of the Alyza IQ. The condensate drain tube of the Alyza IQ is in the recess of the condensate drain adapter. Any condensate forming will first fill the recess in the adapter before overflowing. When enough condensate is present, it closes the condensate drain tube so that no air humidity can penetrate the housing.

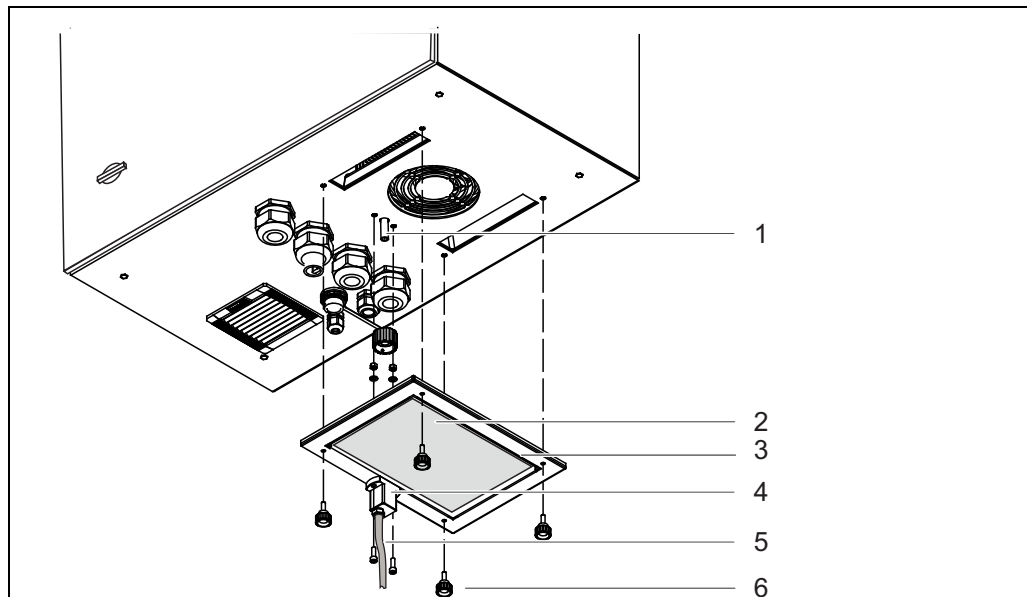
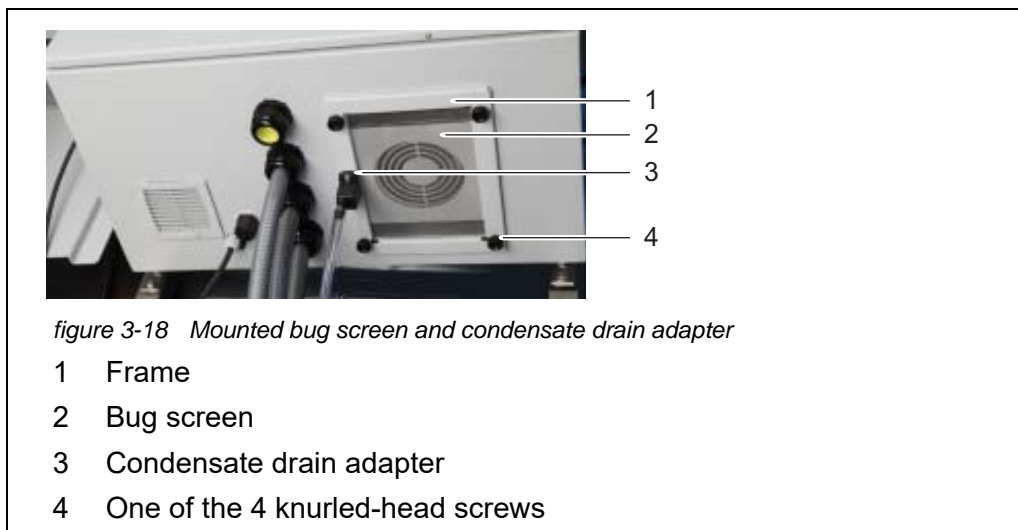

figure 3-17 Mounting the bug screen and condensate drain adapter

- 1 Condensate drain tube (black) at the housing bottom
- 2 Bug screen
- 3 Frame with seal
- 4 Condensate drain adapter with 2 screws
- 5 Condensate drain tube (transparent)
- 6 4 knurled-head screws

- Installation**
- 1 Screw the condensate drain adapter (4) with 2 screws to the frame (3) so that the tube nozzle of the adapter is on the outside of the frame.
 - 2 Plug the transparent condensate drain tube (5) onto the tube nozzle of the condensate drain adapter (4) as far as it will go.
 - 3 Insert the bug screen (2) in the frame so that it is kept in position by the seal of the frame (3).
 - 4 Position the frame (3) with the bug screen (2) and the mounted condensate drain adapter (4) at the underside of the housing. When doing so, the black condensate drain tube (1) at the underside of the housing should exactly fit into the recess of the condensate drain adapter (4).
 - 5 Screw the frame (4) to the housing bottom using the 4 knurled-head screws.



3.3.12 Mounting the terminal holder (TM)

Operating the Alyza IQ, especially while maintenance activities are being executed at the open measuring unit, requires a terminal mounted in the vicinity (e.g. MIQ/TC 2020 3G or DIQ/S 28X). The terminal should be mounted at the left-hand side of the Alyza IQ so that the terminal is always visible while maintenance activities are being executed at the open measuring unit.

The accessory Terminal holder (TM) enables to install a terminal, irrespective of the mounting of the Alyza IQ (mounting stand SM, rail mounting accessory RM, wall mounting accessory WM), in the vicinity of the Alyza IQ.

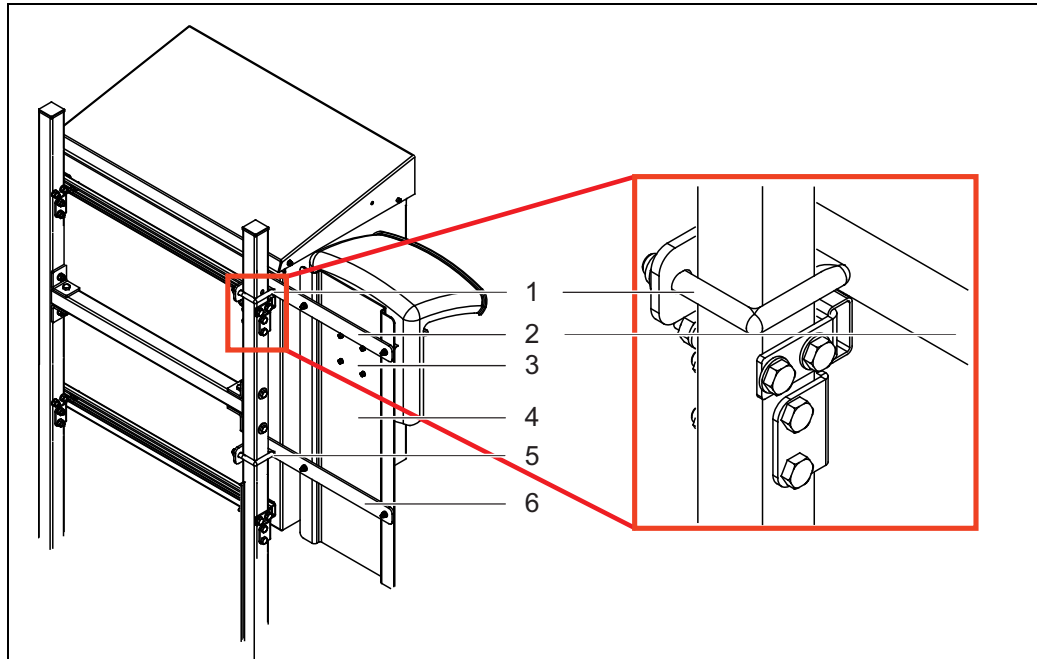

figure 3-19 Installed terminal holder TM (view of the rear side)
Example: Installation on an SM stand mount

- 1 Upper bracket
- 2 Upper angle bracket
- 3 Bore holes for the canopy
- 4 Mounting sheet
- 5 Lower bracket
- 6 Lower angle bracket

Preparing the mounting stand or rail mounting accessory for the terminal holder

The terminal holder is installed at the left-hand side of the Alyza IQ. Thus the terminal is always visible, even with maintenance activities being executed at the open housing of the Alyza IQ.

- 1 Position the mounting stand with the Alyza IQ mounted. The rear of the mounting stand has to be freely accessible.
- 2 Insert the long side of an angle bracket (2) between the housing and mounting stand, above the upper C-rail and past the mounting stand until the short side of the angle bracket touches the mounting stand. Keep the angle bracket in this position.
- 3 Position a bracket (1) on the mounting stand and insert the ends of the bracket in the bore holes of the angle bracket. Fix the angle bracket (2) to the bracket loosely with 2 nuts.
- 4 Insert the long side of the second angle bracket (6) between the housing and mounting stand, under the lower C-rail and past the mounting stand until the short side of the angle bracket touches the mounting stand. Keep the angle bracket in this position.

- 5 Position the second bracket (5) on the mounting stand and insert the ends of the bracket in the bore holes of the angle bracket. Fix the angle bracket (6) to the bracket loosely with 2 nuts.

Installation on a mounting stand or rail mounting accessory

- 1 Screw the mounting sheet (4) to both brackets (2, 6) with 4 hexagon socket screws and nuts.
- 2 On the rear side of the mounting sheet (4), plug four screws into the drillings (3) far enough so that they can be seen on the other side.
- 3 Hold the mounting sheet (4) in the desired height and tighten the 4 nuts at the brackets (1, 3) until the terminal holder is safely mounted.

Installation on a wall

- 1 On the rear side of the mounting sheet (4), plug four screws into the drillings (3) far enough so that they can be seen on the other side.
- 2 Screw the mounting sheet (4) to the wall.

Installing the canopy and terminal

- 1 Tighten the 4 screws to fix the canopy to the mounting sheet (4).



At the bottom of the mounting sheet, keep some space free for the cabling of the power supply.

- 2 Mount an IQ module (e.g. MIQ/JB, DIQ/S 28X, ...) to the canopy (see IQ SENSORNET system operating manual).
- 3 Dock a terminal onto the MIQ/JB as necessary.
- 4 Connect the IQ SENSORNET cable of the Alyza IQ to the IQ module (see IQ SENSORNET system operating manual).
- 5 If necessary, connect the IQ module with a second IQ SENSORNET cable to integrate the Alyza IQ into an existing IQ SENSORNET (see IQ SENSORNET system operating manual).

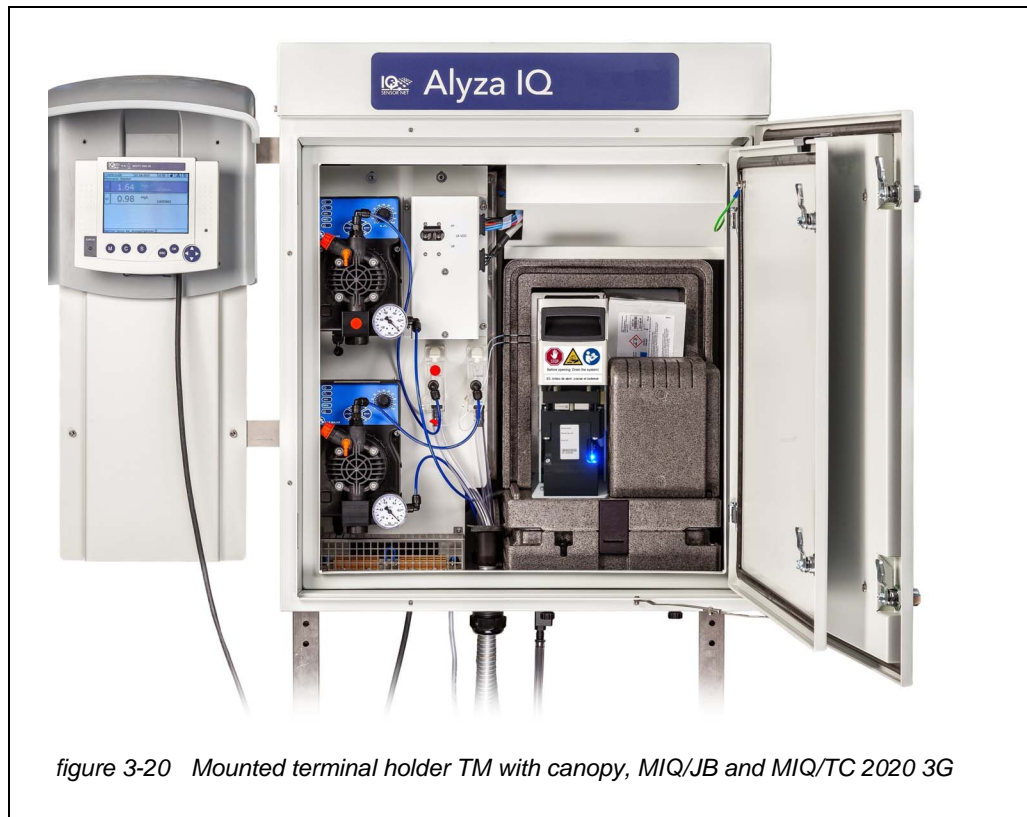

3.3.13 Connecting the power cable and heat tracing lines



For all work done with the housing open:

- If the Alyza IQ was already in operation:
Before opening the measuring unit, start the maintenance routine at the terminal.
- Note the environmental conditions (see section 3.3.1 Requirements of the measurement location, 27).
- Open the outer housing door far enough so the arrestable brake-stay (on the lower right side of the housing) catches.
- Open the inner housing door far enough so that it touches the outer door. Tilt the angular sheet (at the inside of the outer door) over the upper edge of the inside door.

The intake lines and return lines are inserted into the housing through dust-proof lead-in ducts. The cable glands with seals are at the bottom of the housing.

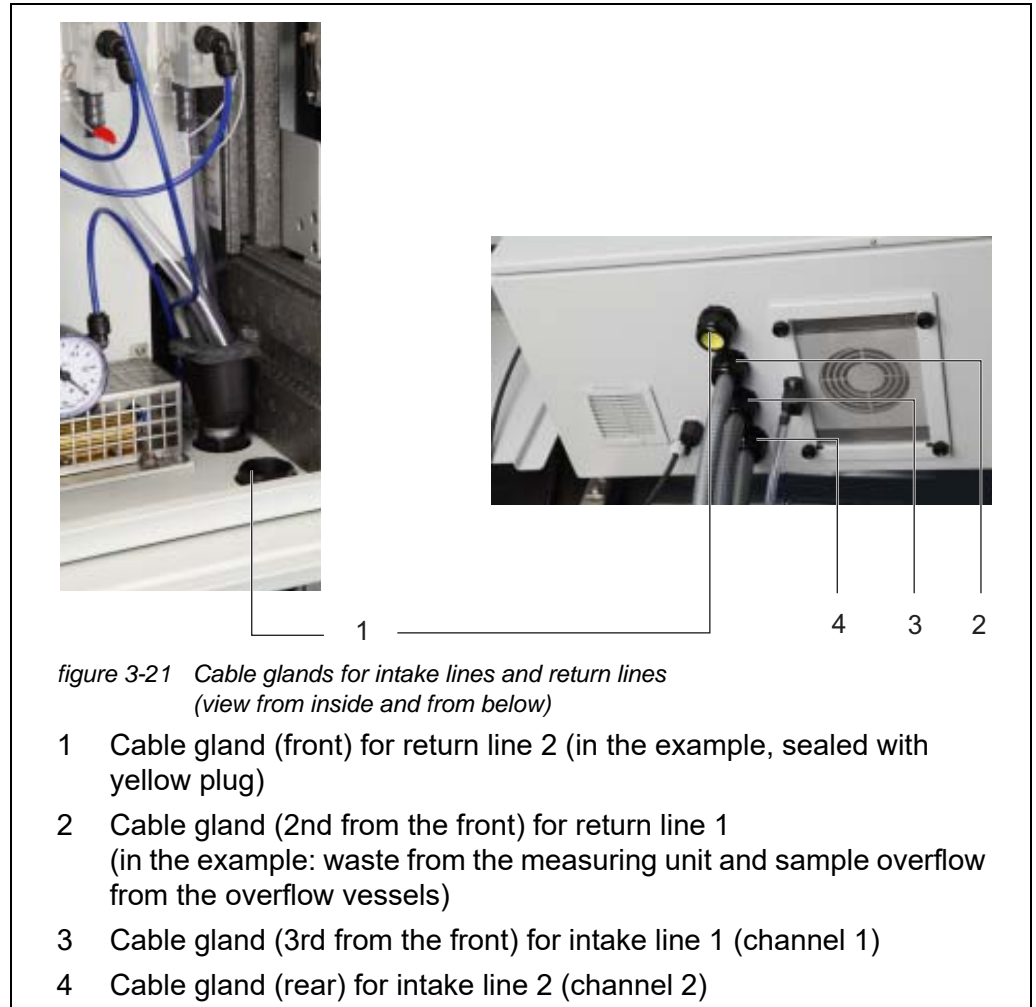

Opening the power box
(to connect the heat tracing)



WARNING

If the power supply is connected incorrectly, there may be danger to life from electric shock.

Pay attention to the following points during installation:

- The power supply box may only be connected to the power supply by a qualified electrician.
- The power supply box may only be connected to the power supply when it is not carrying any voltage.
- The power supply must fulfill the specifications given on the nameplate and in chapter 8 Technical data, ¶ 168.
- The power supply of the heat tracing must fulfill the specifications given on the heat tracing (240 VAC or 120 VAC).
- To operate a heat tracing line, a fault current protection switch (ground fault circuit interrupter) has to be installed.
- The power cable must meet the requirements according to the technical data (see section 8.4, ¶ 173).

In the delivery condition, the power cable (2 m length) is connected to the terminals in the power supply box of the Alyza IQ and is run outside through the housing bottom of the Alyza IQ.

The power cable is delivered without plug. It is designed to be directly connected to the power supply. Note the safety requirements (see section 3.3.2 Safety requirements of the electrical installation, ¶ 27).



If necessary, you can install a longer power cable in the power supply box (see section 3.3.13 Connecting the power cable and heat tracing lines, ¶ 50). When doing so, note the requirements of the power cable (see section 8.4 Electrical data, ¶ 173).

Install an additional external power interrupter to be able to switch the power supply box potential free from outside.

If a heat tracing is connected, a fault current protection switch (ground fault circuit interrupter) and a fuse must be installed additionally.

To connect to the power supply box a heat tracing or power cable, the mounting plate has to be removed.

- 1 Open the outer housing door far enough so the arrestable brake-stay (on the lower right side of the housing) catches.
- 2 Open the inner housing door far enough so that it touches the outer door. Tilt the angular sheet (at the inside of the outer door) over the upper edge of the inside door.

Switching off the power supply

- 3 Switch off all filtration pumps (STOP).
- 4 Switch off the 24 V power supply.
- 5 Switch the power line potential free.

Removing the mounting plate

- 6 Unscrew the 2 fixing screws of the cover (on the top right side in the housing) and remove the cover of the ACM.



If the filtration pumps have already been in operation, sample liquid may escape when the tubes and liquid lines are unscrewed. Provide a collecting container in such a case.

- 7 Remove the cable connections and the connections of the tubes and liquid lines from the mounting plate:
 - Unplug the 2 cables from the switch box.
 - Unscrew the sample tubes from the overflow vessels.
 - Unplug the blue intake lines of the filtration units.
 - Pull the sample overflow tubes out of the collection funnel.
- 8 Remove the mounting plate:
 - Unscrew the 2 fixing nuts (3) at the bottom of the mounting plate.
 - Unscrew the 2 fixing screws (2) at the upper edge of the mounting plate.Secure the mounting plate against falling out.

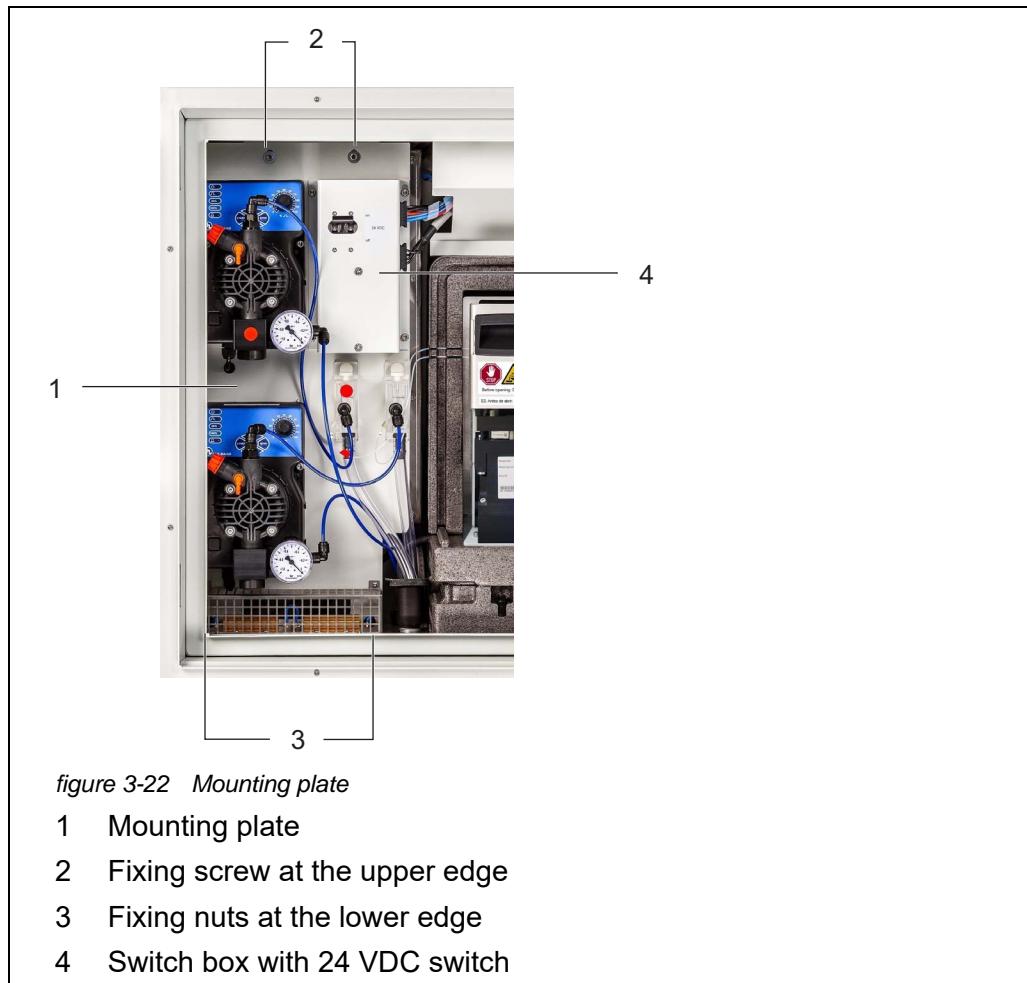

- 9 Remove the mounting plate:
- Lift the mounting plate upward over the threaded pins.
 - Tilt the upper edge of the mounting plate somewhat backwards and remove the mounting plate from the housing downwards.
 - Place the mounting plate with the rear side down on a protected surface (e.g. with cardboard).
- Opening the power box
- 10 Unscrew all nuts with safety disks (10 pieces) from the power supply box and remove the lid of the power supply box.

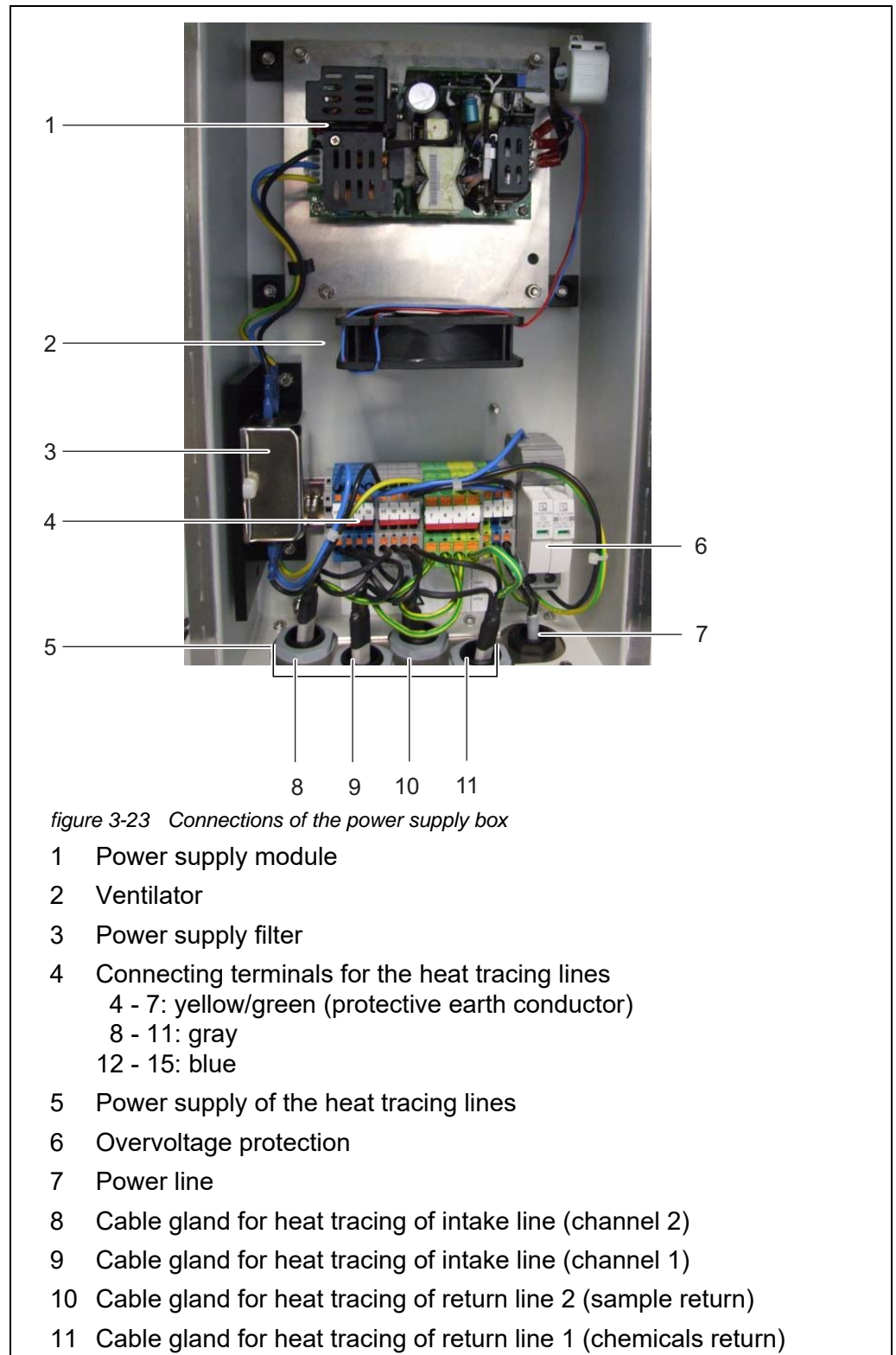

- 11 Unscrew the nuts of the cable glands for the cables of the heat tracing at the underside of the power supply box.

Connecting the intake lines and return lines

- 12 On the underside of the power supply box, remove the protective plugs from those cable glands you need to connect the cables. Unused cable glands have to be closed with the supplied black plugs.
- 13 Only for variants with 2 sample channels:
Run the intake line for channel 2 through the big rear cable gland (from the rear housing panel) at the housing bottom.
- The sleeve tube should protrude into the interior approx. 1 cm to protect the intake line from being damaged (see figure 3-25).
 - Fix the sleeve tube with the cable gland.
- 14 Run the intake line for channel 1 through the second big cable gland (from the rear housing panel) at the housing bottom.
- The sleeve tube should protrude into the interior approx. 1 cm to protect the intake line from being damaged (see figure 3-25).
 - Fix the sleeve tube with the cable gland.
- 15 Run the return line for waste from the measuring unit through the next big cable gland at the housing bottom.
- The sleeve tube should end flush with the tube inside the housing so that a collection funnel can be installed.
 - Fix the sleeve tube with the cable gland.



The liquid in the return line must be able to flow freely (steady slope). Do not immerse the end of the return line in water.

- 16 To guide the sample return into the basin and dispose of the chemicals waste separately:
Install the collection funnel (WF Set) (see section 3.3.15 Mounting the WF Set (collection funnel for sample overflow), 62).

- 17 To guide the sample return into the basin and dispose of the chemicals waste separately:
Run the return line for sample through the front big cable gland at the housing bottom.
- The sleeve tube should end flush with the tube inside the housing so that a collection funnel can be installed.
 - Fix the sleeve tube with the cable gland.
 - Position a suitable collecting container for the chemical waste under the Alyza IQ and secure it.
Empty the collecting container regularly.
 - Put the return line for the chemical waste into the collecting container and secure it.
 - The chemical waste in the return line must be able to flow freely (steady slope). The end of the return line must not be immersed in water or the liquid chemicals collected.



1 2 3 4 5 6

figure 3-24 Connections at the housing bottom (from below)
Example: 2 sample channels, 1 drain

- 1 IQ SENSORNET cable
- 2 Power line
- 3 Variants with 2 sample channels:
Gland for sleeve tube of intake line (channel 2)
- 4 Gland for sleeve tube of intake line (channel 1)
- 5 Gland for sleeve tube of return line 1
- 6 Gland for sleeve tube of return line 2
(in the example it is unused and sealed with a yellow protective plug)



Unused cable glands of the basic instrument have to be closed with the yellow protective plugs supplied.

Connecting the cable with the power supply box

NOTE

*No other consumers, with the exception of those described in this operating manual, may be connected to the power supply box.
Line branches in the supply lines are not permitted.*

- 18 Slide the nut of the cable gland (of the power supply box) over the cable of the heat tracing.
- 19 First run the wire with the greatest diameter (protective earth conductor, yellow/green) through the sealing of the cable gland.
- 20 Then run the two thinner wires (black) of the heat tracing through the sealing of the cable gland.
- 21 Push the entire cable with the cable sheath through the sealing until the cable is visible in the power supply box.
- 22 Insert the cables of the heat tracing lines for the intake lines and return lines through the cable glands on the underside.
- 23 Seal unused cable glands with the black plugs supplied.
Thus the power supply box is closed and protected against dust and moisture.
- 24 Screw tight the nut of the cable gland (with a torque of 7.5 Nm).
- 25 Insert all heat tracing cables into the power supply box.
- 26 Insert the heat tracing wires into the respective terminals so that each terminal catches.
Green/yellow cable: any green/yellow terminal
1st black cable: any blue terminal
2nd black cable: any gray terminal



The heating bands of the heat tracing must start within the housing of the Alyza IQ to keep the lines frost free. At the outlet of the return line, the heat tracing must protrude 20 to 50 mm from the sleeve tube. If necessary, shift the heat tracing in the sleeve tube accordingly.

- 27 If necessary, replace the power cable with another power cable (e.g. a longer one).
- 28 Check whether all connections are made correctly.
- 29 Screw tight the nut of the cable gland of the power cable (with a torque of 2.5 Nm).



Make sure that no cable touches the power supply filter.

Closing the power supply box

- 30 Remount the lid of the power supply box and screw tight all nuts with safety disks as far as they will go (0.4 Nm).

Reinserting the mounting plate

- 31 Insert the mounting plate:
- Plug the mounting plate on the threaded pins inside the housing.
 - Tighten the 2 fixing screws (2) at the upper edge of the mounting plate.
 - Tighten the 2 fixing nuts (3) at the bottom of the mounting plate.
- 32 Re-establish the cable connections and the connection of the tubes and liquid lines.
- Connect the 2 cables to the switch box.
 - Mount the collection funnel:
 - the collection funnel for the chemical waste and, if necessary,
 - the second collection funnel for the sample overflow from the overflow vessels.
 - Plug the intake lines onto the connectors of the filtration pumps.
 - Screw the sample tubes to the connectors of the overflow vessels.
 - Re-insert the sample overflow tubes into the collection funnel for the sample overflow or into the joint collection funnel for chemical waste and sample overflow.
 - Connect the liquid lines (see section 3.3.17 Connecting the tubes and liquid lines, 66).
 - Insert the sample return tubes of the overflow vessels in the collection funnels:
- 33 Reinsert the cover and fix it with the 2 fixing nuts.

3.3.14 Mounting the collection funnel

The liquid waste from the measuring unit and sample overflow from the overflow vessels have to be transported out of the housing of the Alyza IQ.

The collection funnel collects the liquids from up to 3 sources (waste tube from the measuring unit, sample overflow tube from overflow vessel 1 and sample overflow tube from overflow vessel 2) and transports them out of the housing via a common return line.

To keep moisture and damp air from penetrating the housing of the Alyza IQ, the collection funnel is closed with a rubber cover. Unused openings of the rubber cover are closed with plugs.

The collection funnel is installed in the housing of the Alyza IQ at the second cable gland from the front.



It is possible to dispose of the sample overflow and chemical waste from the measuring unit separately by using a second collection funnel (accessory WF Set). The second collection funnel is installed at the front cable gland. There the sample return is transported out of the housing separately (see section 3.3.15 Mounting the WF Set (collection funnel for sample overflow), 62).

**Scope of delivery
of the collection
funnel of the
Alyza IQ**

- Collection funnel
- Rubber cover for collection funnel
- 3 plugs for the openings of the rubber cover
- 2 sample overflow tubes (from the overflow vessel to the collection funnel)
- Cable ties to fasten the collection funnel to the fixing bracket.

**Preparatory
activities**

When operating heat tracing lines for the return lines:
Install the heat tracing first (see chapter section 3.3.13 Connecting the power cable and heat tracing lines, 50).



Install the collection funnel together with the heat tracing lines. If the mounting plate is removed, there is more room to install the collection funnel.

Mounting



figure 3-25 Collection funnel for the common discharging of all liquids
(lateral view)

- 1 Heating line of the heat tracing
(attached to the fixing bracket with a cable tie)
- 2 Waste tube of the measuring unit
- 3 Sample overflow tube from the overflow vessel
- 4 Rubber cover of the collection funnel
(close any unused openings with plugs)
- 5 Cable ties
- 6 Fixing angle bracket
- 7 Collection funnel
- 8 Cable gland (2nd from the front)
- 9 Cable gland (in the front)

- 1 Insert the return line into the housing from the outside through the cable gland (8). Inside, the end of the waste tube should be flush with the cable gland (8).
Details on how to install the return lines and heat tracing lines:
see section 3.3.13 Connecting the power cable and heat tracing lines,
📖 50
- 2 Fix the heat tracing (1) of the return line to the fixing angle bracket behind the cable gland with the cable tie (scope of delivery: collection funnel).
- 3 Insert the collection funnel (7) in the opening of the cable gland (8) in the housing:
 - the beveled side of the collection funnel (7) points to the heat tracing (1)
 - the drain of the collection funnel flows into the return line
- 4 Press the collection funnel down till it sits tight.

- 5 Pull the rubber cover (4) of the collection funnel over the edges of the collection funnel.
The opening of the collection funnel has to be closed tightly.
- 6 Put the waste tube (2) of the measuring unit into the collection funnel through the small opening of the rubber cover (4).
The liquid in the waste tube must be able to flow freely (steady slope, no kinking, no damage).
- 7 If all liquids are disposed of through a common return line:
Put the sample overflow tubes (3) of the overflow vessels into the collection funnel through the big openings of the rubber cover (4).

NOTE

Make sure that the liquids in the collection funnel can drain off freely. A blocked collection funnel can cause the liquids to overflow into the housing of the Alyza IQ . Liquids can cause damage to the housing and electrical components.

- 8 Close any unused openings of the rubber cover (4) with the plugs provided so that the housing interior is protected against humidity.

If the liquids are disposed of via a second collection funnel available as an accessory (WF Set) (see section 3.3.15 Mounting the WF Set (collection funnel for sample overflow), 62).

3.3.15 Mounting the WF Set (collection funnel for sample overflow)

To transport from the housing the liquid chemical waste from the measuring unit separately from the sample overflow, install a second collection funnel (accessory, WF Set). Via the second collection funnel, only the sample overflow from the overflow vessels is transported out of the housing.

To collect and dispose separately of the chemical waste from the measuring unit, a suitable (chemical resistant, winterproof) collecting container is required additionally.

Scope of delivery of the WF Set

- Collection funnel
- Rubber cover for collection funnel
- 3 plugs for the 3 openings of the rubber cover
- Sample overflow tube, transparent
- Fixing angle bracket for the heating line at the foremost cable gland with cheese-head screws (M3x8)
- Cable ties to fasten the collection funnel to the fixing bracket

Mounting

- 1 Fix the fixing angle bracket at the front cable gland.

- 2 Insert the sleeve tube of the return line for the sample overflow into the housing from the outside through the cable gland (9). Inside, the end of the return tube should be flush with the cable gland (9).
Details on the how to install the sleeve tubes and heat tracing lines: see section 3.3.13 Connecting the power cable and heat tracing lines,  50
- 3 Insert the collection funnel (7) in the opening of the cable gland (9) in the housing:
 - the beveled side of the collection funnel (7) points to the heat tracing (1)
 - the drain of the collection funnel flows into the return line for the sample return.
- 4 Pull off the short sample overflow tubes from the overflow vessels.
- 5 Cut off pieces of the transparent sample overflow tube included in the scope of delivery long enough that the new sample overflow tubes go from the overflow vessels to the foremost collection funnel.
- 6 Plug the fitted sample overflow tubes to the overflow vessels.

NOTE

Make sure that the liquids in the collection funnel can drain off freely. A blocked collection funnel can cause the liquids to overflow into the housing of the Alyza IQ. Liquids can cause damage to the housing and electrical components.

- 7 Pull the rubber cover (4) of the collection funnel over the edges of the collection funnel.
The opening of the collection funnel should be closed tightly.
- 8 Put the sample overflow tubes of the overflow vessels into the collection funnel through the big openings of the rubber cover.
- 9 Close any unused openings of the rubber cover with the plugs provided so that the housing is protected from humidity.

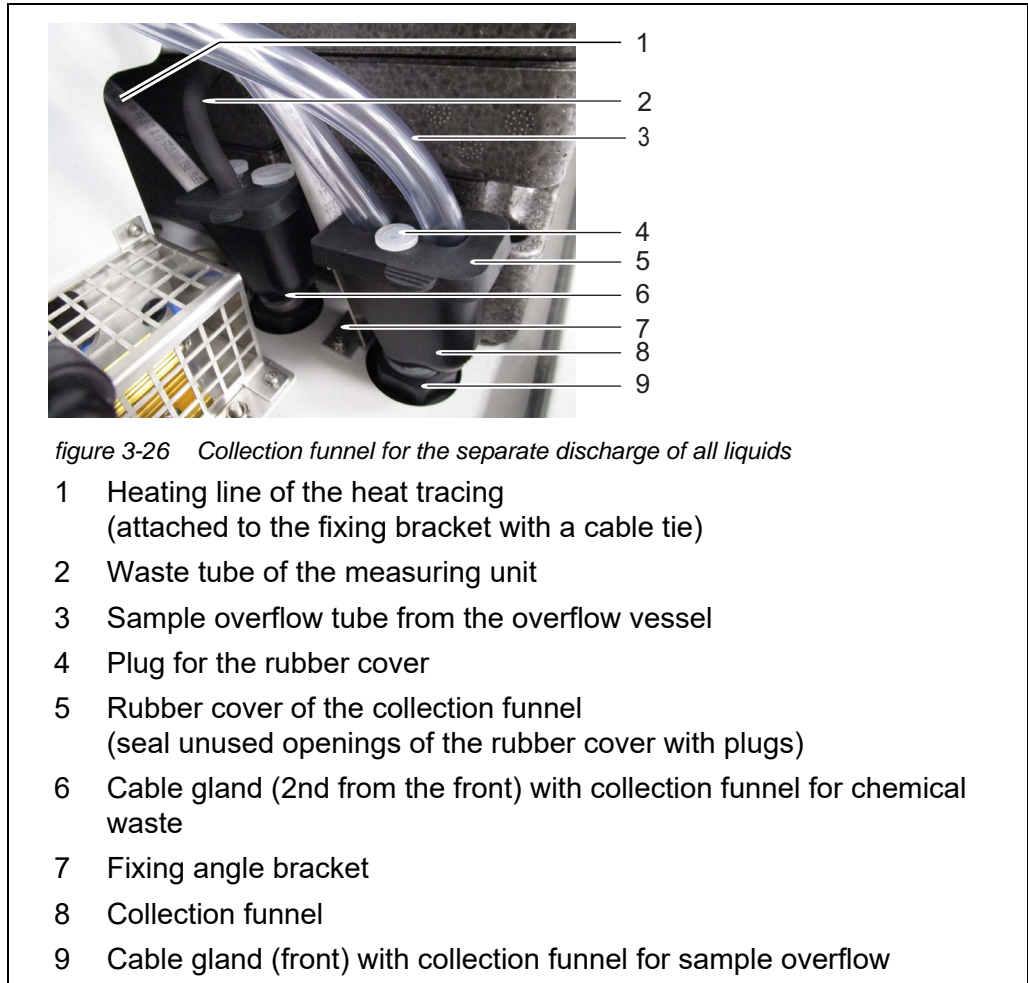

- 10 Position a suitable collecting container (chemical resistant, winterproof) under the Alyza IQ to collect the chemical waste from the measuring unit.
- 11 Fasten the collecting container.
- 12 Insert the return line of the cable gland (6) into the collecting container.
- 13 Fasten the return line.
- 14 Empty the collecting container regularly.

3.3.16 Installing the FM/PC filter module and M 1.5 basin holder for filtration

Installation instructions

Heed the following notes when installing the filter module:

- Mount the filter module so that the plate is in a position vertical to the flow direction.



In special cases (e.g. in a channel) it is better to mount the FM/PC filter module in a horizontal position in the flow direction.
An adapter for horizontal mounting is available as an accessory.

- The filter module (FM/PC) and the slide must be completely submersed (max. 40 cm).
Take changing water levels into account when mounting the filter membrane module.
- The lower edge of the filter module must be mounted with at least 10 cm distance to the bottom.

NOTE

Dirt particles and contamination in the sample tube can block the valves of the measuring unit.

During the cleaning activities, make sure that no dirt particles get into the open tube ends or the connector of the filter module.

Protect the open tubes and connectors during the cleaning activities, e.g. with blind plugs.

Installation

- 1 Mount the rail of the basin holder for filtration in the basin.
If necessary, extend the rail with the M-EXT 1.5 extension accessory.

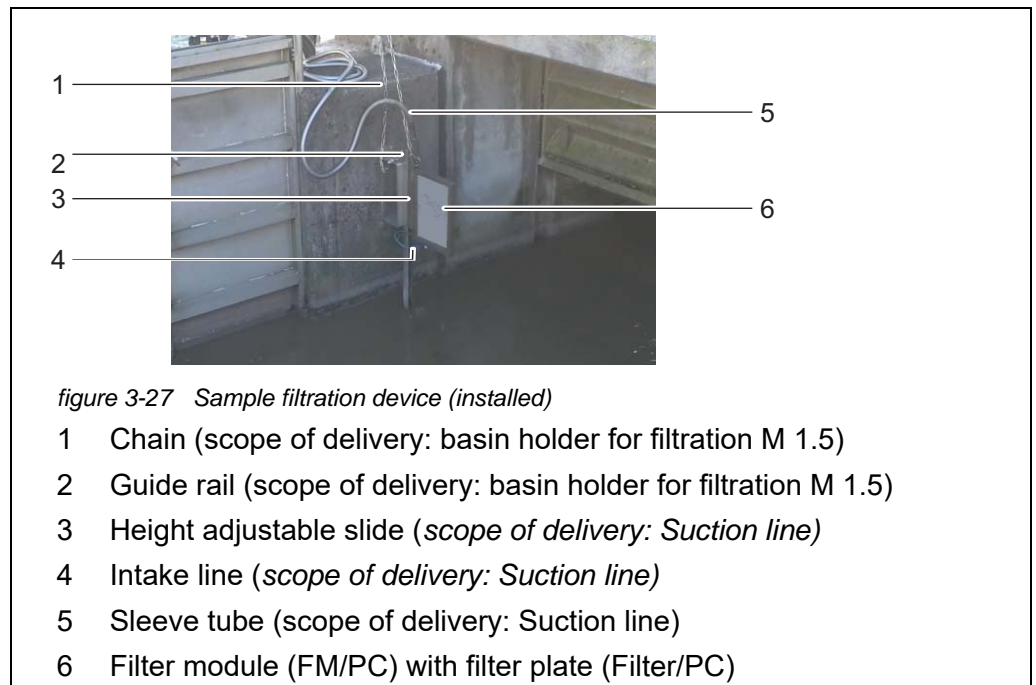

- 2 Mount the filter module on the slide of the basin holder for filtration.
- 3 Connect the intake line to the filter module.

- 4 Insert the slide of the filter module in the rail and lower it into the basin with the aid of the chain. Fix the end of the chain outside the basin.
- 5 Run the intake line to the Alyza IQ. Fix the sleeve tube with cable ties at some suitable places as necessary. How to connect the intake line to the Alyza IQ, (see section 3.3.17 Connecting the tubes and liquid lines,  66).

3.3.17 Connecting the tubes and liquid lines

After connecting the intake lines to the housing, connect the following tubes and liquid lines:

- the blue intake lines to the filtration pumps
- the sample feed tubes of the pumps to the overflow vessels
- the transparent sample overflow tubes of the overflow vessels to the collection funnel for the sample overflow
- the transparent sample tubes of the measuring unit to the overflow vessels
- the black waste tube of the measuring unit to the collection funnel for chemical waste or to the collection funnel for the sample overflow.



For all work done with the housing open:



- If the Alyza IQ was already in operation:
 - Before opening the doors, start the maintenance routine at the terminal.
 - Note the environmental conditions (see fig. 3.3.1,  27).
 - Open the outer housing door far enough so the arrestable brake-stay catches.
 - Open the inner housing door far enough so that it touches the outer door. Tilt the angular sheet (at the inside of the outer door) over the upper edge of the inside door.

fig. 3-28,  67 shows the housing with the completely connected lines including the accessories and all options:



Proceed as follows to connect each line:

- 1 Connect the intake line 1 to the filtration pump 1.

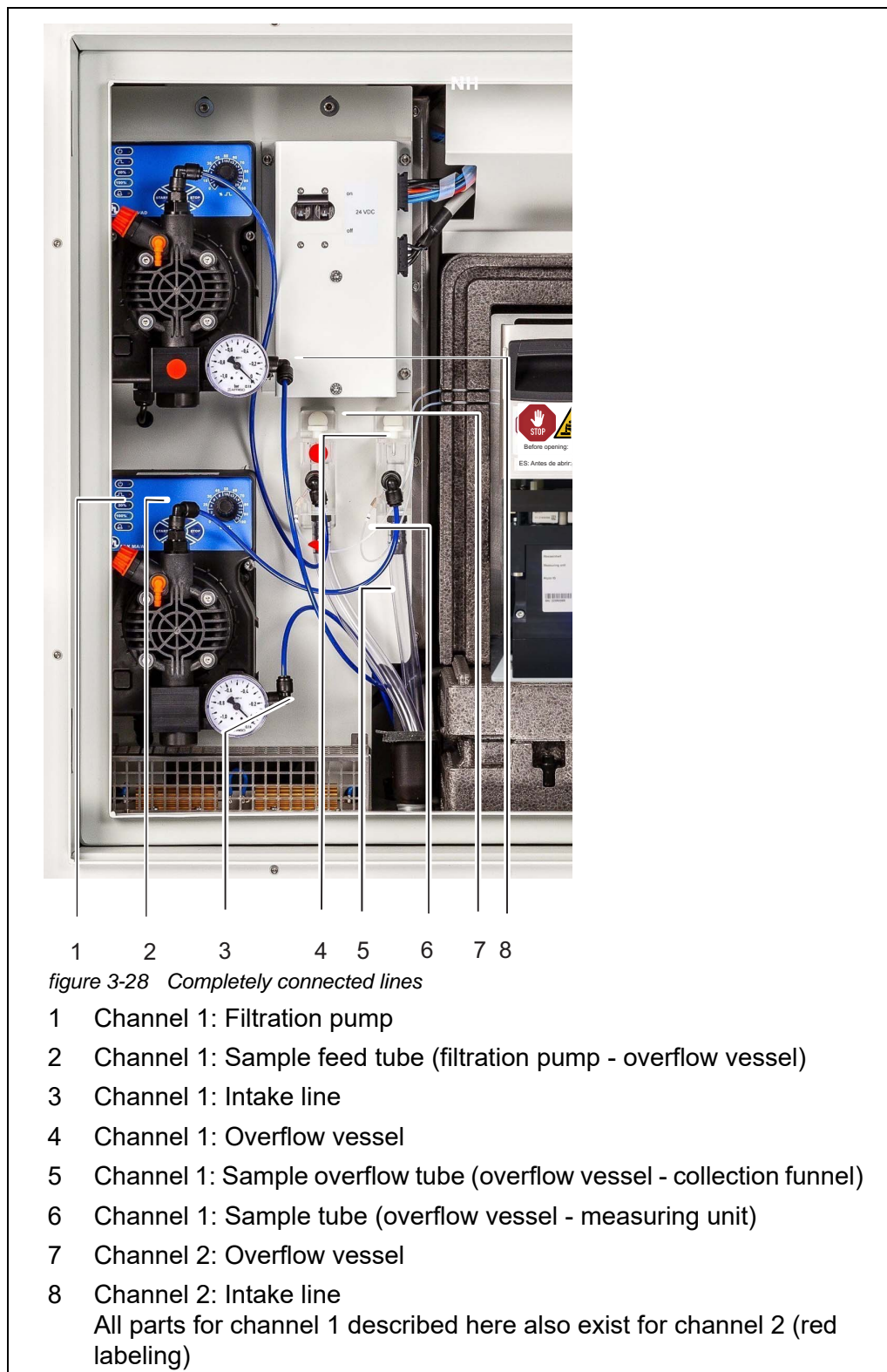
- 2 Connect the intake line 2 to the filtration pump 2.
- 3 Connect the sample tubes to the overflow vessels.
The sample tube (channel 2) for overflow vessel 2 has a red labeling.

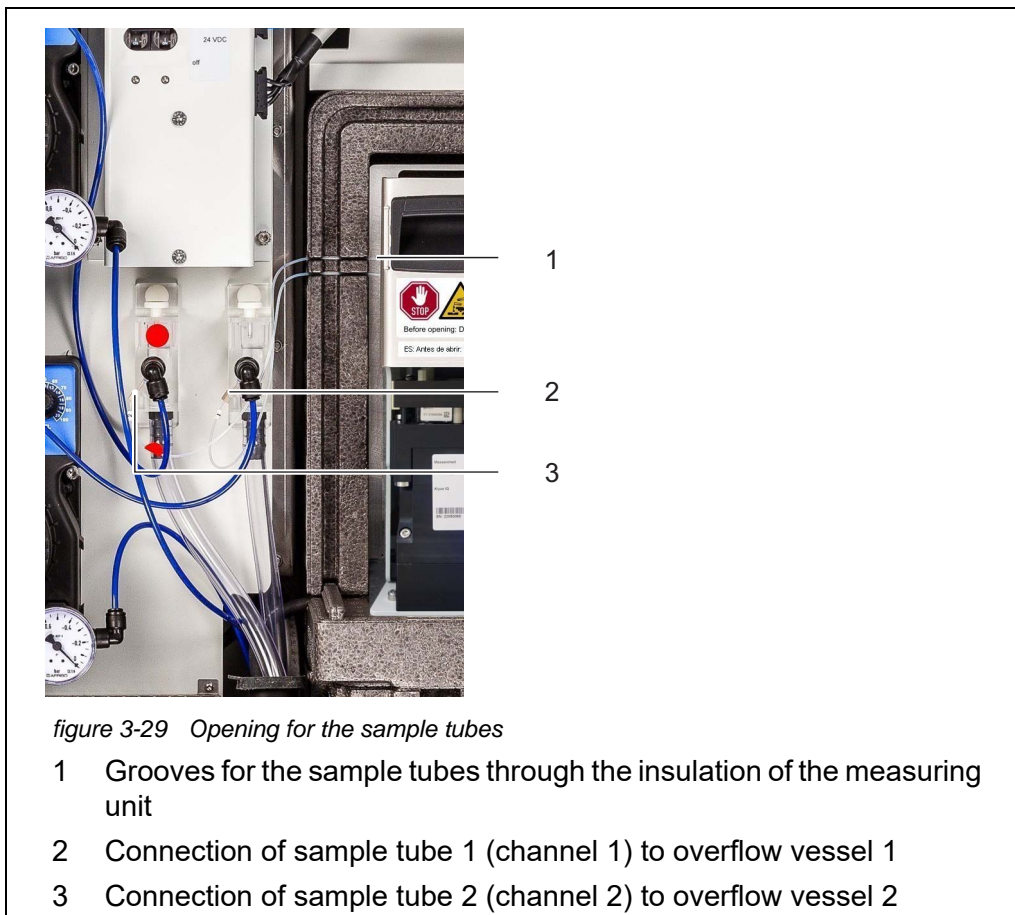

- 4 Carefully press the sample tubes into the grooves (1) left of the measuring unit so that the sample tubes are not bent even when the front cover is closed.
- 5 Install the collection funnel for the chemical waste.
- 6 If necessary, install the collection funnel for the sample overflow.
- 7 Insert the waste tube of the measuring unit into the collection funnel for the chemical waste of the measuring unit.
The liquid in the waste tube must be able to flow freely (steady slope, no kinking, no damage).

- 8 Insert the sample overflow tubes from the overflow vessels into the collection funnel for the sample overflow.
- Collection funnel at the foremost cable gland:
(with separate disposal of the chemical waste from the measuring unit)
- or
- Collection funnel at the second cable gland:
(with joint disposal of the chemical waste from the measuring unit and of the sample overflow into the container)



The liquids in the return lines have to be able to drain off freely (steady slope). Do not immerse the end of the line in water.

- 9 Check whether the pre-installed sample feed tubes are correctly connected to the filtration pumps and overflow vessels

3.3.18 Setting up a connection with the IQ SENSORNET system

In the delivery condition the IQ SENSORNET cable (2 m long) is connected to the ACM control unit of the Alyza IQ and is run to the outside through the bottom plate.

Connect the IQ SENSORNET cable of the Alyza IQ to an IQ SENSORNET module mounted in the vicinity.



For detailed information on how to connect the IQ SENSORNET cable to an IQ SENSORNET module mounted in the vicinity please refer to the IQ SENSORNET system operating manual, paragraph "Distributed mounting".

If the Alyza IQ is operated in an IQ SENSORNET configured minimally, we recommend that you set the terminator switch in the MIQ module (e.g. MIQ/JB) to ON (see IQ SENSORNET system operating manual).

Example of a simple IQ SENSORNET system:

- 1 TerminalController (e.g. MIQ/TC 2020 3G),
- 1 MIQ module (e.g. MIQ/JB),
- 1 sensor (e.g. Alyza IQ)

3.3.19 Taking the filtration pumps into operation

- 1 Make sure that all lines (intake lines, return lines) and tubes (sample feed tube, sample overflow tube, sample tube, waste tube) in the Alyza IQ are connected correctly.
- 2 Set the 24 VDC switch on the mounting plate to ON (I pressed upward).
- 3 Use the rotary knob to set the pump capacity to 80 ... 100 %.

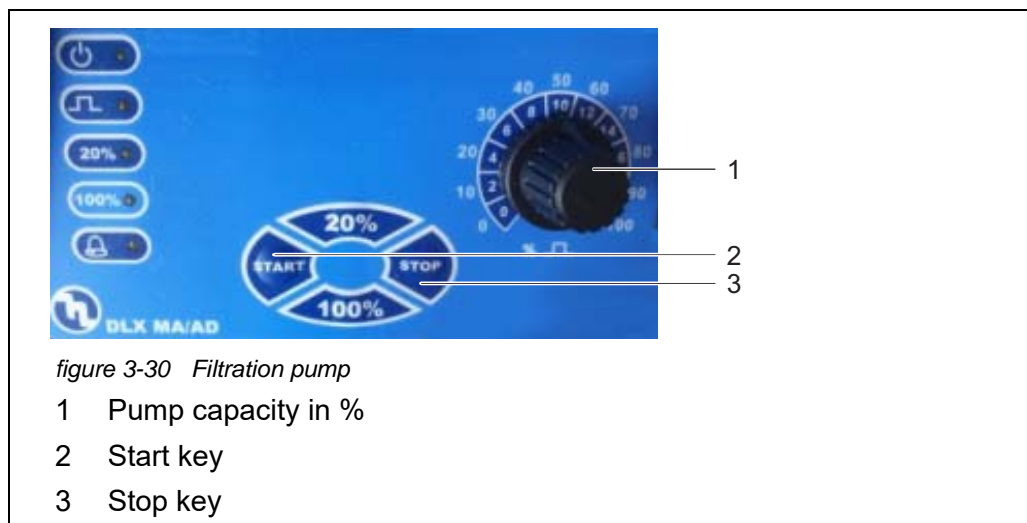

- 4 Switch on the filtration pump with the Start key.
- 5 Wait until sample liquid runs from the overflow vessel into the sample overflow tube. Depending on the length of the intake line, this may take some minutes.



If no sample runs into the overflow vessel, proceed in one of the following ways.

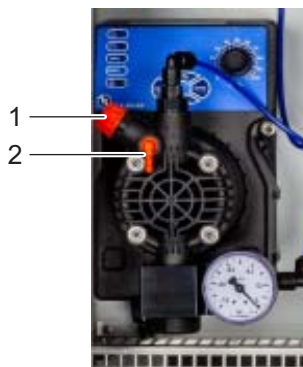

figure 3-31 Filtration pump

- 1 Vent valve
- 2 Vent connection

- Open and then close again the ventilation valve (1).
- Fill the intake line with water manually:
 - Switch off the filtration pump.
 - Pull the intake line off the filtration pump.
 - Fill the intake line with water (e.g. using a wash bottle).
 - Connect the intake line to the pump again and secure it.
 - Switch the filtration pump on again.
- Increase the suction power manually:
 - At the vent connection (2), connect a syringe with a tube:
 - Open the vent valve (1).
 - Create an additional negative pressure with the syringe.
 - Close the vent valve (1).
 - Repeat the procedure until sample runs into the overflow vessel.
 - Remove the tube and syringe from the vent connection (2).

- 6 As soon as a sufficient amount of sample is flowing, reduce the pump capacity as far as possible (to approx. 2 - 10 %) with the rotary knob.



Adjust the pump capacity so that the sample overflow can drain off through the sample overflow tube into the collection funnel for the sample overflow.

No sample may come into the housing through the vent valve (1).

- 7 Alyza IQ variant with 2 sample channels:
Take the second filtration pump into operation.
- 8 Let the sample feed run continuously, until the sample flow is stable and no more air is in the lines.
- 9 Close the doors of the housing.
- 10 If necessary, put the IQ SENSORNET system into operation (see the relevant IQ SENSORNET system operating manual).

3.4 Initial commissioning



For all work done with the housing open:

- If the Alyza IQ was already in operation:
Before opening the measuring unit, start the maintenance routine at the terminal.
- Note the environmental conditions (see fig. 3.3.1, 72).
- Open the outer housing door far enough so the arrestable brake-stay catches.
- Open the inner housing door far enough so that it touches the outer door. Tilt the angular sheet (at the inside of the outer door) over the upper edge of the inside door.

For initial commissioning, proceed as follows:

- 1 Check all connections and tubes connecting the Alyza IQ with the outside world (see section 3.4.1 Checklist for commissioning, 72)
- 2 Install the replacement parts required in the Alyza IQ with the aid of the install wizard (section 3.4.3 Carrying out the install wizard, 74).
- 3 Complete the initial commissioning at the terminal of the IQ SENSORNET (see section 3.4.4 Preparing the Alyza IQ for measuring, 76)
- 4 In an IQ SENSORNET system without automatic air pressure compensation:
Set the local altitude at the IQ SENSORNET in the menu **<S>** / *Settings / System settings / Location altitude/Air pressure* (see IQ SENSORNET system operating manual).

3.4.1 Checklist for commissioning

With the aid of the following questions, check whether the Alyza IQ is ready to start operating:

- Is the housing of the Alyza IQ installed safely (see section 3.3.4 Installing the housing, 30) ?
- Are all lines (intake lines, return lines) and tubes for inlet and outlet of the sample installed section 3.3.17 Connecting the tubes and liquid lines, 66) ?
- Are the heat tracing lines installed to protect the intake and return lines against frost (see section 3.3.13 Connecting the power cable and heat tracing lines, 50) ?
- Is the Alyza IQ safely connected to the power supply?
Is there an external power disconnecter?
- Are the filtration pumps ready for operation and is the pump capacity adjusted (see section 3.3.19 Taking the filtration pumps into operation, 70) ?

- Is sample present in the overflow vessels?
- Does the sample in the overflow vessels meet the quality requirements (see section 8.2 Application conditions, 169)?
- Is the Alyza IQ connected to the IQ SENSORNET (MIQ/JB + Terminal/Controller, is the Alyza IQ displayed as a sensor on the IQ SENSORNET terminal, see section 3.3.18 Setting up a connection with the IQ SENSORNET system, 69) ?
- Was the correct altitude or correct air pressure entered in the IQ SENSORNET system (menu <S> / Settings / System settings / Location altitude/Air pressure, see IQ SENSORNET system operating manual) ?
- If a collecting container for separate disposal of the chemical waste is installed:
Are the collecting container and return line fastened?
Is regular emptying secured?

3.4.2 Stick the label (national language) onto the locking device of the MultiPort valve

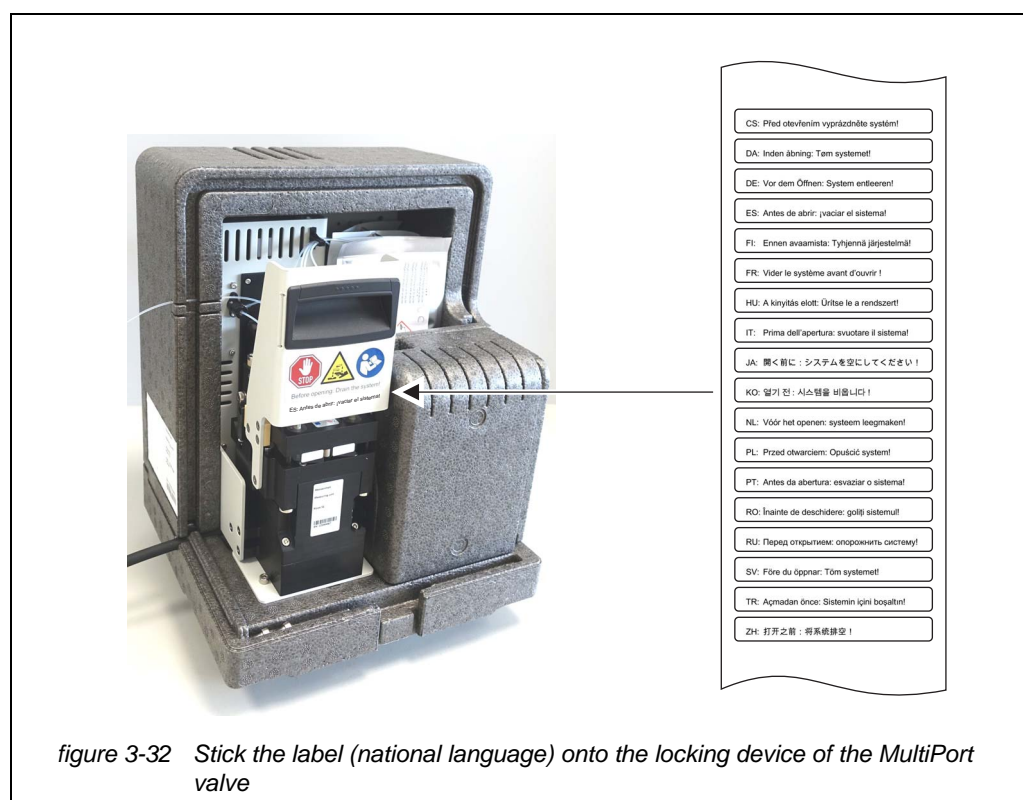

3.4.3 Carrying out the install wizard

When all requirements for the commissioning are met, start the install wizard to install the replacement parts required.



For the commissioning you have to know how to:

- Open the measuring unit,
- Install the MultiPort valve (MPV),
- Install the ChemBag,
- Install the tube at the MultiPort valve (MPV)
- Close the measuring unit.

Details on the individual steps are given in the present operating manual of your Alyza IQ. When the Alyza menu is opened, the install wizard starts automatically until a first valid configuration of the Alyza IQ is available.

The install wizard does no longer automatically start once the parts required have been installed.

As soon as the controller of the IQ SENSORNET identifies the Alyza IQ, the channels of the Alyza IQ are displayed in the measured value display of the IQ SENSORNET.

Before the first measurement, bars are displayed.

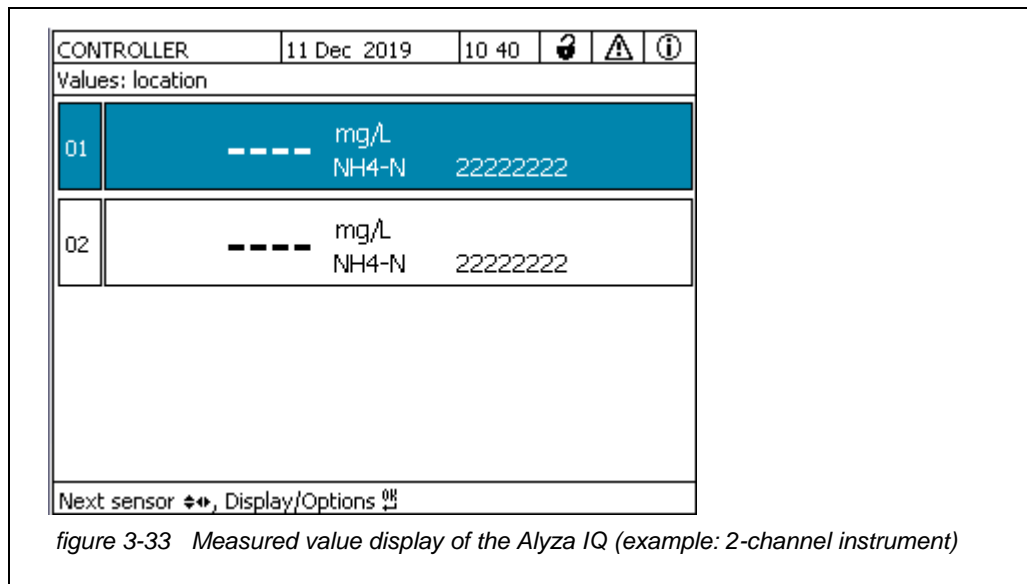

- 1 Highlight the measured value display of the Alyza IQ.
- 2 Open the Alyza menu with **<C>**.
On initial commissioning, the install wizard of the Alyza IQ opens automatically.

- 3 Put on your personal protective equipment (PPE) and chemical resistant gloves (see section 2.4 Personal protective equipment (PPE), [124](#)).

**WARNING**

Dangerous chemicals.
Improper use of chemicals can cause damage to your health.

Heed the following rules:

- **Read the labels of the ChemBags and follow the safety instructions**
- **Wear protective equipment (lab coat, protective goggles, chemical resistant protective gloves, safety shoes)**

- 4 Open the outer housing door far enough so the arrestable brake-stay (on the lower right side of the housing) catches.
- 5 Open the inner housing door far enough so that it touches the outer door. Tilt the angular sheet (at the inside of the outer door) over the upper edge of the inside door.
- 6 Remove the front cover of the measuring unit.
 - Using one hand, grip the handle at the upper edge of the front cover of the measuring unit.
 - Pull the front cover of the measuring unit somewhat to the front against the resistance.
 - Carefully take the front cover out to the front and put it in a clean place.
- 7 Start the install wizard.
- 8 Follow the instructions of the install wizard.
 - **Step 1:**
Configure all settings requiring the installation of replacement parts (ChemBags, tubes). From them, the install wizard makes a list of the replacement parts required.
 - **Step 2:**
Install the replacement parts required (MultiPort valve, tube, ChemBags).
Details on installing the replacement parts (see section 5.5 Installing / exchanging the ChemBags, MPV, tubes, [109](#)).
- 9 Re-insert the front cover of the measuring unit.
- 10 Close the housing of the Alyza IQ.

- 11 Prepare the Alyza IQ for measuring (see section 3.4.4 Preparing the Alyza IQ for measuring, 76)

3.4.4 Preparing the Alyza IQ for measuring

After completing the install wizard, carry out some further steps at the terminal of the IQ SENSORNET.

- 1 Open the Alyza menu / tab *Maintenance / Manual maintenance*.
- 2 Carry out the function *Prepare measuring* (Alyza menu / tab *Maintenance / Manual maintenance / Prepare measuring*).
- 3 Switch to the menu *Maintenance / Manual maintenance*.

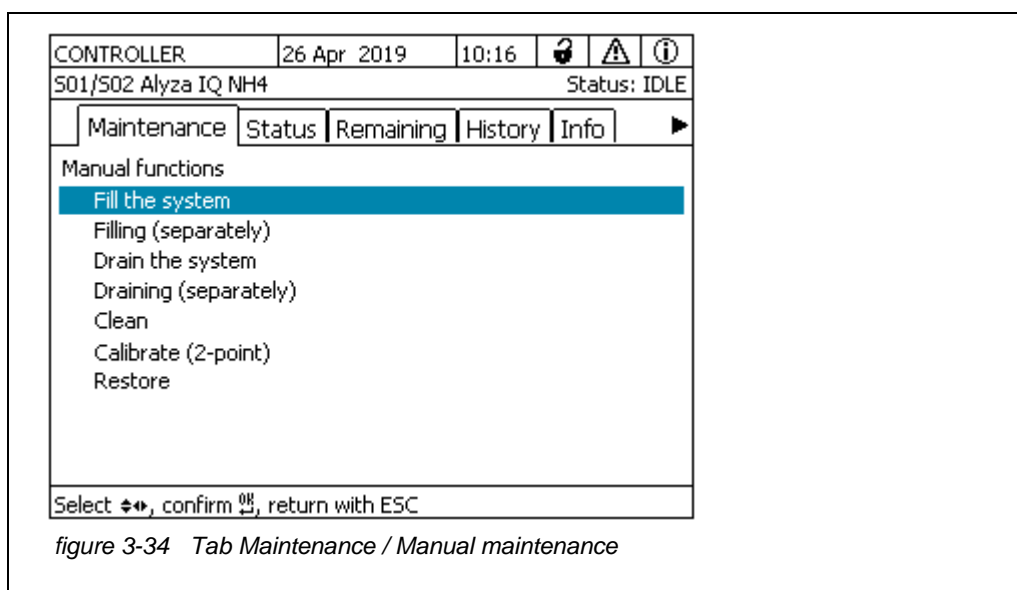

- 4 Carry out the function *Fill the system*. (Alyza menu / tab *Maintenance / Manual maintenance / Fill the system*)
The tubes and MultiPort valve (MPV) are filled.
When the function has been successfully completed, the message *Filling successfully completed.* is displayed.
- 5 Quit the menu *Manual maintenance* with **<ESC>**.

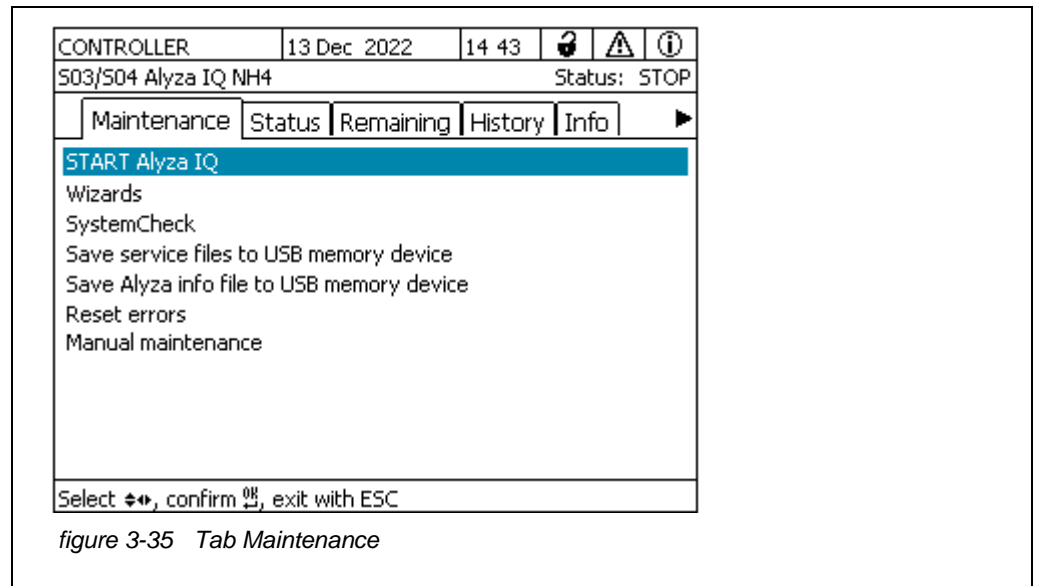

figure 3-35 Tab Maintenance

- 6 Carry out the function *START Alyza IQ*.
Measurement is started and the measured value is displayed in the measured value display after approx. 10 minutes.
Wait for the temperature adjustment to be completed.
- 7 If necessary, switch off the maintenance condition.
(Alyza menu, tab *Maintenance / Switch on/off the maintenance condition*).
- 8 Check the settings for measurements (see section 4.3.1 IQ SENSORNET Settings of sensors and diff. sensors, 80)

4 Measurement / Operation

4.1 General operating principles

Contrary to the general operating principles of the IQ SENSORNET, the Alyza IQ is operated via a separate menu (Alyza menu) at the IQ SENSORNET terminal.

Opening the Alyza menu

- 1 In the measured value display, use <▲▼> to select the Alyza IQ.
- 2 Using the <C> key, switch to the Alyza menu.
The Alyza menu opens with the tab *Status*. The tab *Status* provides information on the current operating status of the Alyza IQ.

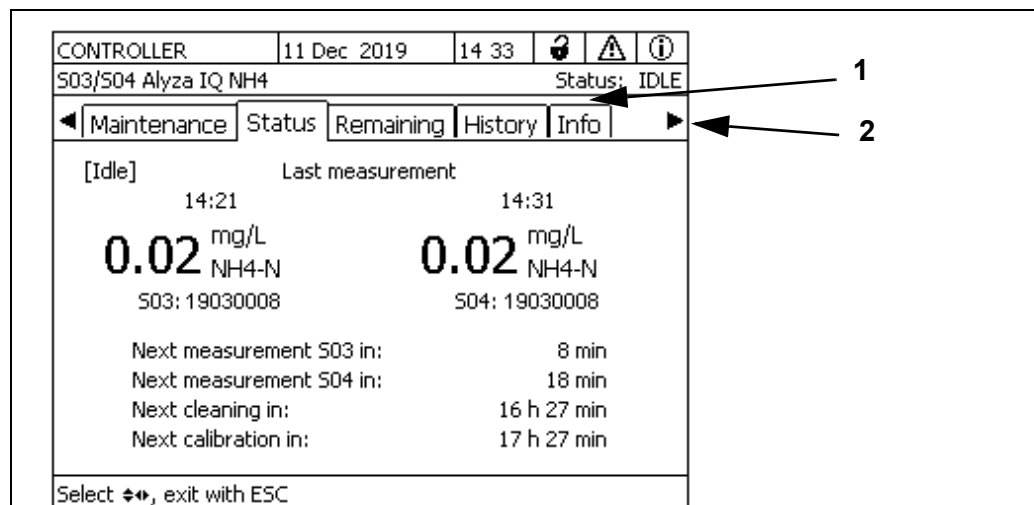

figure 4-1 Alyza menu tab Status

- 1 Tabs form the first menu level in the Alyza menu
 - To switch between the tabs, use the arrow keys <◀><▶>. Information, submenus and functions of the selected tabs are displayed.
 - To switch between the displayed information, submenus and functions within a tab, use the arrow keys <▲><▼>. Open the submenus with <OK>.
- 2 Arrows on the side of the screen
More tabs can be accessed with the arrow keys <◀><▶>. With the arrow keys <▲><▼> you can access further information within a tab.

In the Alyza menu,

- you have access to information on the current operating condition (tabs *Status*, *Remaining*, *History*, *Info*)
- you can start the calibrating and service functions (tab *Maintenance*), e.g.:
 - stop or start the Alyza IQ
 - Activate or terminate the maintenance condition
 - Start calibration
 - Start the service functions

4.2 Measurement operation

4.2.1 Determination of measured values

The Alyza IQ determines the measured values with a chemical analyzing procedure. The measured values are determined at intervals specified in the settings (see section 4.3 Settings for the Alyza IQ, 80).

If the intervals overlap with the specified start times and intervals of other functions (*Autom.cleaning* or *Autom.calibration*), the functions are carried out according to their priority (see section 4.3.2 Priority, 83).

4.2.2 Starting the measuring operation

The Alyza IQ starts measuring only when the *START Alyza IQ* function is started.

When the Alyza IQ is started (function *START Alyza IQ*), it checks automatically whether the requirements for measurement are met, e.g.:

- Plausible pressure and volume conditions in the tubes
- Temperature control of the various areas of the Alyza IQ
The regulating of the temperature may take up to 30 minutes.

More details: See section 3.4.4 Preparing the Alyza IQ for measuring, 76.

4.2.3 Measuring

The measured values are displayed in the measured value display on the terminal.

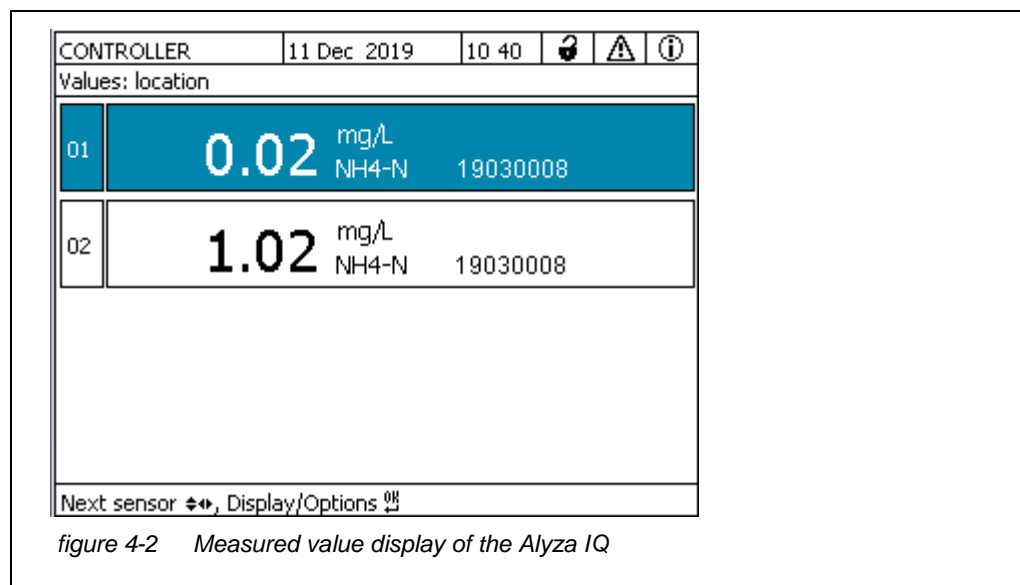

The current Alyza IQ measured values are also displayed in the Alyza menu, tab *Status*. More detailed information on the current status is available here, (e.g. next measurement, next cleaning, next calibration).

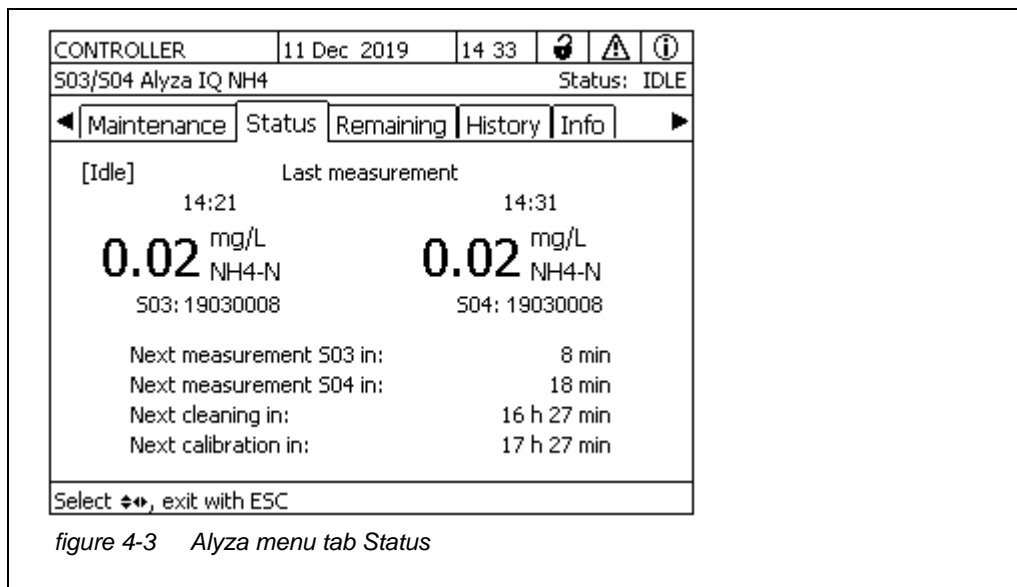

figure 4-3 Alyza menu tab Status



During an automatic cleaning or calibrating procedure, the display shows CLEAN or CAL instead of a measured value. Linked outputs are frozen.

Measured value display	Function
CLEAN	<i>Autom.cleaning</i> is being carried out.
CAL	<i>Autom.calibration</i> is being carried out.

4.3 Settings for the Alyza IQ

For the Alyza IQ, the settings are done like that for the other IQ SENSORNET sensors in the menu *Settings of sensors and diff. sensors* (IQ SENSORNET measured value display / <S> / *Settings of sensors and diff. sensors*).

Start the measuring operation so the measured values of the Alyza IQ can be displayed (see section 4.2.2 Starting the measuring operation, 79).

4.3.1 IQ SENSORNET *Settings of sensors and diff. sensors*

- 1 Use the <M> key to switch to the measured value display as necessary.
- 2 Using <S>, switch from the measured value display to the main menu of the sensor settings.
- 3 Then navigate to the menu *Settings of sensors and diff. sensors*. The exact procedure is given in the IQ SENSORNET system operating manual.

4 Adjust the setting values as necessary.

Setting table Setting menus with the possible values to be set. Default values are marked in bold.

Setting menu	Possible values	Description
<i>Measuring mode</i>	NH4-N NH4 NH3-N	The measured parameter is displayed in the selected citation form.
<i>Measuring range</i> With the setting <i>Measuring mode: NH4-N, MR1</i>	0.02 .. 5.00 mg/L 0.02 .. 5.00 ppm	Depending on the setting of the <i>Measuring mode</i> , different measured variables can be selected within the low (MR1) or high (MR2) measuring range. The configuration (ACM and ACS) and the installed parts (ChemBags) determine whether measurements in the low (MR1) or high (MR2) measuring range are possible. To change between the large and small measuring range, different ChemBags have to be installed (see section 5.6 Changing the measuring range, 122).
With the setting <i>Measuring mode: NH4-N, MR2</i>	0.10 .. 20.00 mg/L 0.10 .. 20.00 ppm	
With the setting <i>Measuring mode: NH4, MR1</i>	0.03 .. 6.00 mg/L 0.03 .. 6.00 ppm	
With the setting <i>Measuring mode: NH4, MR2</i>	0.13 .. 25.00 mg/L 0.13 .. 25.00 ppm	
With the setting <i>Measuring mode: NH3-N, MR1</i>	0.02 .. 5.00 mg/L 0.10 .. 20.00 mg/L	
With the setting <i>Measuring mode: NH3-N, MR2</i>	0.02 .. 5.00 ppm 0.10 .. 20.00 ppm	
<i>Offset correction</i> With the setting ● <i>Measuring mode NH4-N</i> or <i>NH3-N</i> and ● <i>Measuring range 0.02 .. 5.00 mg/L, MR1</i>	- 0.50 ... 0.00 ... + 0.50 mg/L	For other measuring modes and measuring ranges, the value ranges are adjusted.
With the setting ● <i>Measuring mode NH4-N</i> or <i>NH3-N</i> and ● <i>Measuring range 0.10 .. 20.00 mg/L, MR2</i>	- 2.00 ... 0.00 ... + 2.00 mg/L	

Setting menu (general settings)	Possible values	Description
<i>Meas. interval</i>	10 , 15, 20, 30, 45, 60 min 2, 4, 6, 8, 12 h	Measuring interval
<i>Damping</i>	Off <i>Signal smoothing</i> <i>median filter</i>	Methods for filtering the signals A signal filter in the sensor reduces the limits of variation of the measured value. For details, see section 4.3.3
With the setting <i>Signal smoothing:</i> <i>Response time t90</i>	100 , 200, 300, 400 s	The signal filter is essentially characterized by the response time t90. Response time of the signal filter (in seconds). This is the time after which 90 % of a signal change is displayed.
With the setting <i>median filter</i>		The instrument displays the median of the last 3 measurements as the measurement value.
<i>Autom.cleaning</i>	<i>On</i> Off	Switches the automatic cleaning function on or off
● <i>Interval</i>	6, 12, 24 , 48, 96	Interval in h
● <i>Ref.time hours</i>	0 ... 7 ... 23	Defines the start time from which the automatic cleaning procedures will take place at the set interval (default setting: 7:00 o'clock) PLEASE NOTE: Recommended start time for <i>Autom.cleaning</i> : approx. 1 - 2 hours before <i>Autom.calibration</i> .
● <i>Ref.time minutes</i>	0 ... 59	
● <i>Conditioning count of steps</i>	<i>On</i> 1 ... 10 Off	Adjustable number of rinses subsequent to cleaning.
<i>Autom.calibration</i>	<i>On</i> Off	Switches the automatic calibration function on or off
● <i>Procedure</i>	<i>2 Point</i>	Number of calibration points for automatic calibration.
● <i>Interval</i>	6, 12, 24 , 48, 96	Interval in h

Setting menu (general settings)	Possible values	Description
<ul style="list-style-type: none"> ● <i>Ref.time hours</i> ● <i>Ref.time minutes</i> 	0... 8 ...23 0...59	Defines the start time from which the automatic calibration procedures will take place at the set interval (default setting: 8:00 o'clock) PLEASE NOTE: Recommended start time for <i>Autom.cleaning</i> : approx. 1 - 2 hours before <i>Autom.calibration</i> .
<i>Autost.after PwrOff</i>	On Off	Activate or switch off the automatic start of the Alyza IQ after a power failure
<i>Sample channel</i>	1 2 1+2	Setting of the sample channel from which the sample should be measured. PLEASE NOTE: If channel 2 or 1+2 is selected, channel 2 has to be installed (overflow vessel and filtration pump). If sample only from one channel should be measured, the sample from channel 1 is measured.
<i>Temperature mode</i>	°C °F	Temperature values are displayed in the selected unit
<i>Save and quit</i>		The Alyza IQ stores all changed settings and the display switches to the next higher level.
<i>Quit</i>		The display switches to the next higher level without storing the new settings.



The *Autom.cleaning*, *Autom.calibration* and *Meas. interval* settings may result in the overlapping of the carrying out of different functions.

In this case, the functions are carried out according to priority.

4.3.2 Priority

Function	Priority	Duration (min)
<i>Autom.cleaning</i>	1	5 (1-channel variant)
<i>Autom.calibration</i>	2	40
Measuring	3	10

4.3.3 Damping

The Alyza IQ determines the measured values not continuously but at defined intervals.

Two consecutive measured values can be quite different due to various reasons. Possible reasons are

- actual concentration changes in the sample
- influence on the measured value determination not based on the sample.

With the *Damping* you can specify how the Alyza IQ displays and transmits the measured values.



For 2-channel instruments, the damping can be set separately for each of the two channels.

Damping Off

The measured value is displayed immediately and unchanged.

Signal smoothing

The last measured value is displayed with a delay.

Every 20 seconds the *Signal smoothing* function creates a display value in the range between the last and the current measured value. This display value gradually approximates the actual measured value during the time specified (*Response time t90*).

The *Response time t90* is the time after which 90 % of a signal change is displayed.

Median filter

The last determined measured value is only displayed if it meets the criteria for the median.

The *median filter* function selects the medium value of the last 3 measured values as the displayed value. The extreme values (upper and lower extreme value) are discarded.



The median filter only becomes active when three directly succeeding measured values are present.

Example:

Measuring interval 10 min: The median filter is active after 30 min.

4.4 Calibration

4.4.1 Overview

Why calibrate?

During operation, individual components of the Alyza IQ can age or become dirty with time and thus change their characteristics, e.g.:

- Flow through cell
- LED of the photometer

- Photo diodes
- Color reagent

Regular automatic or manual calibration procedures help you to recognize any changes of the measuring characteristics of the Alyza IQ.

2-point calibration	The slope and offset of the characteristic curve are adjusted with a 2-point calibration.
When to calibrate?	Calibrate at regular intervals.
Automatic calibration	Any calibration can be carried out fully automatically at regular intervals.
Manual calibration	An additional, manual calibration can be started in the Alyza menu (tab <i>Maintenance / Manual maintenance</i>) at any time (see section 4.4.2 Calibration,  85).
Calibration record / calibration history	The result of a calibration is stored in the calibration history (see Alyza menu / tab <i>History / Calibration history</i>).
Maintenance condition	<p>To carry out a calibration procedure (automatically or manually), the maintenance condition is always automatically activated for the Alyza IQ in the IQ SENSORNET system. All linked outputs remain in their current status. After an automatic calibration has been finished, the maintenance condition is switched off automatically.</p> <p>After a manual calibration has been finished, the maintenance condition has to be switched off manually.</p> <p>More detailed information on the maintenance condition is given in the IQ SENSORNET system operating manual.</p>



You can also switch off the maintenance condition in the Alyza menu, tab *Maintenance*.

4.4.2 Calibration

Automatic calibration	<p>Automatic calibration is carried out in the measuring operation at regular intervals.</p> <p>The setting of the calibration interval and calibration time is done in the menu <i>Settings of sensors and difference sensors</i> (see section 4.3 Settings for the Alyza IQ,  80).</p>
------------------------------	---



Prior to every automatic calibration, the *SystemCheck* function is carried out. The *SystemCheck* function automatically and regularly checks whether the Alyza IQ is operable (for details, see section 5.11).

Manual calibration	The manual calibration procedure can be started manually at any time if necessary. The calibration procedure is started, and the setting of the standard used
---------------------------	---

is made, in the Alyza menu.

Proceed as follows to start a calibration procedure manually:

Stopping running operation

- 1 In the measured value display, use <▲▼> to select the Alyza IQ.

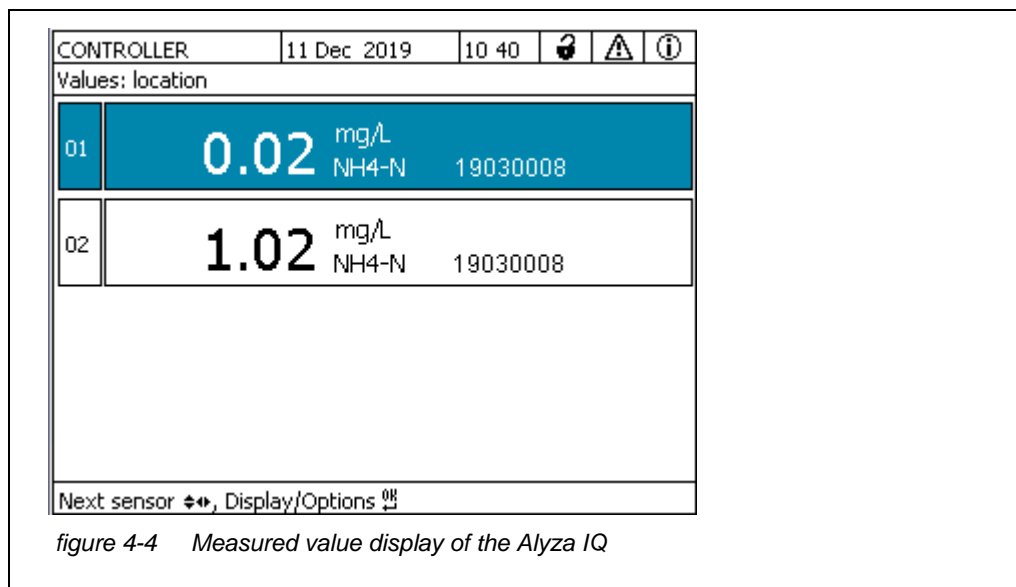

figure 4-4 Measured value display of the Alyza IQ

- 2 Using <C>, open the Alyza menu for the Alyza IQ.
- 3 Using <◀>, switch to the Maintenance tab.

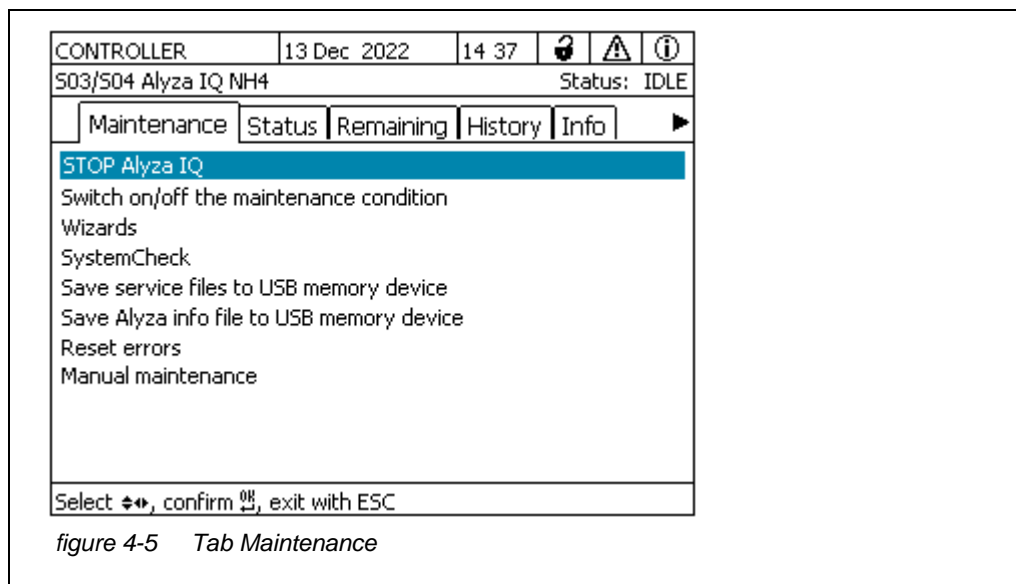

figure 4-5 Tab Maintenance

- 4 Carry out the STOP Alyza IQ function to stop the running operation.
- 5 Confirm the function to stop the running operation. The maintenance condition is automatically activated in the IQ SENSORNET for the Alyza IQ.

- Carry out calibration**
- 6 Open the menu item *Manual maintenance*.
 - 7 Carry out the *Calibrate (2-point)* function.
The calibration procedure runs automatically.
The calibration result is displayed after the calibration standards have been measured.



You have the following possibilities if the calibration failed:

- Repeat the calibration procedure (make sure that the correct calibration standard is connected and selected for calibration).
- Use the last valid calibration (see section 4.4.4 Reactivating the last valid calibration, 88)
- Use the factory calibration (see section 4.4.4 Reactivating the last valid calibration, 88)

Possible calibration results

The calibration data are evaluated by the system. A calibration procedure can have the following results:

Display after calibrating	Meaning/actions
Measured value	Successful calibration
"----"	Calibration unsuccessful (see log book). The Alyza IQ is blocked for measurement. <ul style="list-style-type: none"> ● Carry out maintenance activities immediately (see sensor operating manual). ● View the calibration history in the Alyza menu. ● Check the calibration conditions and calibration standard.

Restarting the measuring operation

- 8 Carry out the *START Alyza IQ* function.
Measurement is started and the measured value is displayed in the measured value display after approx. 10 minutes.
- 9 Carry out the *Switch off the maintenance condition* function.
The maintenance condition is terminated in the IQ SENSORNET for the Alyza IQ.
- 10 In the Alyza menu, use <▶> to switch to the *Status* tab.
The measured value display appears. While no valid measured value is available, the display shows bars «- - -».

4.4.3 Calibration history

The calibration history of the Alyza IQ is available in the Alyza menu (tab *History / Calibration history*).

Example and explanation of a calibration history (see section 4.5.3 Information on maintenance activities and calibration procedures (tab History), 92)

4.4.4 Reactivating the last valid calibration

Manual calibration unsuccessful

If a manual calibration procedure is unsuccessful, the measuring operation can only be resumed once a valid calibration was carried out or reactivated. Thus you can immediately continue to measure if a calibration failed or you suspect that the calibration conditions were not optimally met.

Automatic calibration unsuccessful

If an automatic calibration is unsuccessful, the last valid calibration is automatically reactivated. If three calibration procedures in succession are unsuccessful, the measuring operation can only be resumed once a valid calibration was carried out or manually reactivated.



Reactivating old calibration data is a temporary measure. Take into consideration that the sensor may provide wrong measured values. Ensure the correct functioning of the Alyza IQ by checking and/or recalibrating.

- 1 In the measured value display, use <▲▼> to select the Alyza IQ.
- 2 Using the <C> key, switch to the Alyza menu.
- 3 Using <◀>, switch to the *Maintenance* tab.
- 4 Carry out the *STOP Alyza IQ* function to stop the running operation.
- 5 Confirm the function to stop the running operation.
The maintenance condition is automatically activated in the IQ SENSORNET for the Alyza IQ.
- 6 Carry out the *START Alyza IQ* function.
A menu pops up with the following options:
 - *Repeat calibration*
 - *Use factory calibration*
 - *Use last valid calibration*
 - *Show calibration details*
- 7 Select *Use last valid calibration* or *Use factory calibration*.
- 8 Switch off the maintenance condition.
The measured value is displayed after approx. 10 minutes in the measured value display.

4.5 Information on the Alyza IQ

In the Alyza menu, there is comprehensive information available on the current status of the Alyza IQ:

- Current operating condition (measuring, calibration, etc.)
- Schedule for the next interval-controlled actions, e.g. measuring, calibrating, cleaning (tab *Status*)
- Schedule for the exchange of ChemBags (tab *Remaining*)
- Schedule for the execution of maintenance activities, e.g. replacement parts (tab *History / Installed replacement parts*)
- Documentation of the maintenance activities carried out (tab *History / Maintenance history*)
- Documentation of the calibration procedures (Tab *History / Calibration history*)
- More information on the Alyza IQ (tab *Info*)
 - Current measured values of sensors (e.g. temperature, etc.)
 - Current statuses (e.g. heating, ventilator, cooling, etc.)
 - Software versions of individual components of the Alyza IQ
 - Serial numbers of individual assembly groups

- 1 In the measured value display, use <▲▼> to select the Alyza IQ.
- 2 Using the <C> key, switch to the Alyza menu.
- 3 Using <<>>>, open one of the tabs with information on the Alyza IQ:
 - *Status* (see section 4.5.1 Information on the current operating condition (Tab *Status*), 89)
 - *Remaining* (see section 4.5.2 Information on the expected lifetimes of replacement parts (tab *Remaining*), 90)
 - *History* (see section 4.5.3 Information on maintenance activities and calibration procedures (tab *History*), 92)
 - *Info* (see section 4.5.4 More information on the Alyza IQ (tab *Info*), 95)



You can also additionally transfer to a USB memory device the information displayed via the Alyza IQ (see section 4.6 Transferring information to a USB memory device via the Alyza IQ, 95).

4.5.1 Information on the current operating condition (Tab *Status*)

During measuring operation, the information on the current operation condition

comprises the current measured values and also the schedule for the next interval-controlled actions, e.g. measuring, calibrating or cleaning.

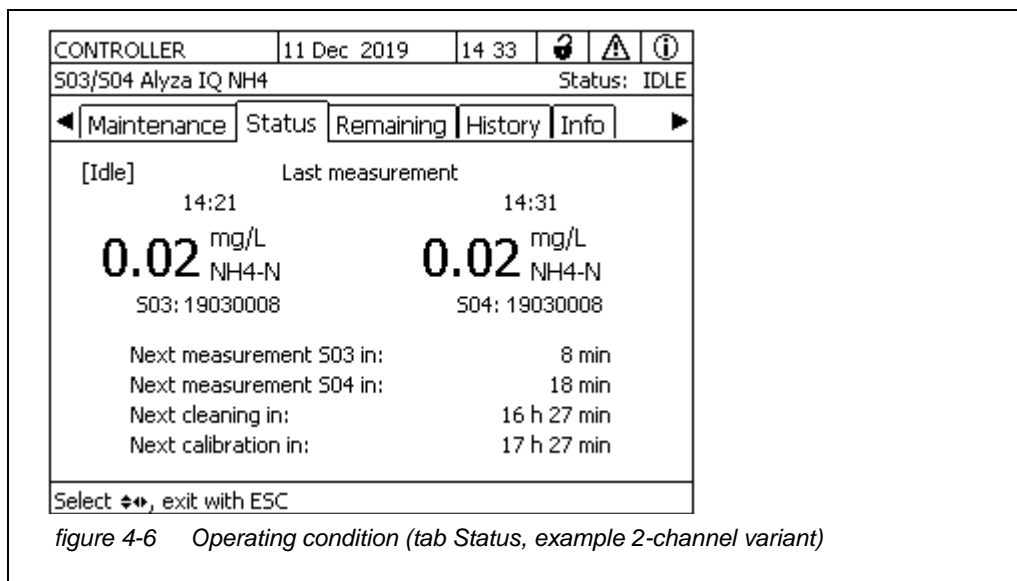

In the *Status* tab, the following information on the current operating condition is available:

- Current operating condition (e.g. measuring, calibration, etc.)
- Measured value of the last measurement with date and time
- Schedule for the next interval-controlled action, e.g. measuring, calibrating and cleaning

4.5.2 Information on the expected lifetimes of replacement parts (tab *Remaining*)

The *Remaining* tab provides a quick overview of the maintenance activities due. This information facilitates the planning and co-ordination of the maintenance activities for the most important replacement parts (chemicals and MultiPort valve) of the Alyza IQ.

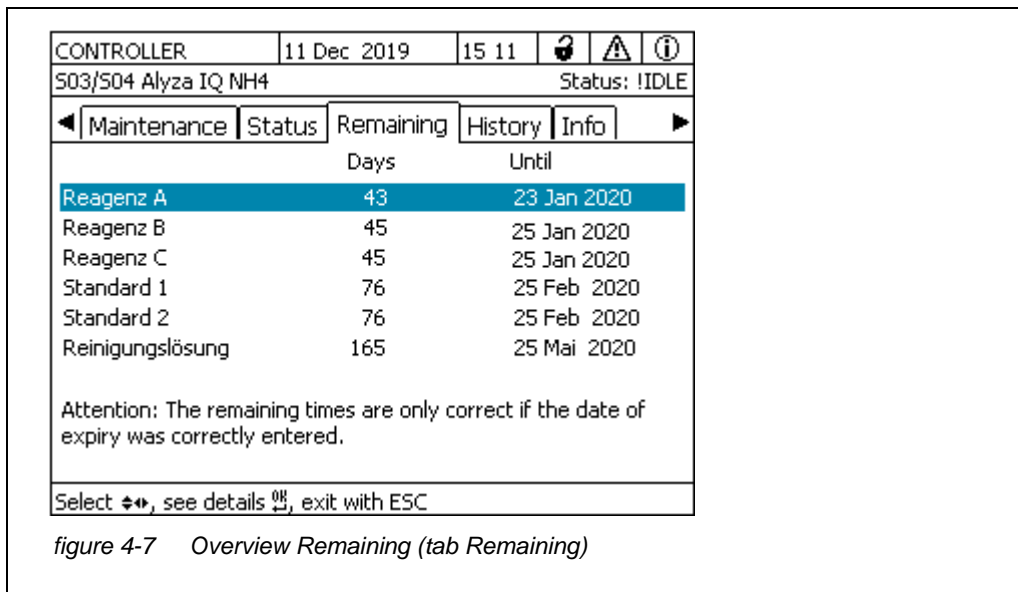

The estimated times remaining until the next exchange are shown in days in the overview. If the times remaining are short, this is also indicated in the display.

Remaining time	Signal
< 30 d	! (next to remaining time)
< 10 d	! (flashes next to remaining time)



- The remaining times can only be stated correctly if
- The exchange is done via the maintenance menu
 - full ChemBags or new replacement parts are installed
 - the expiry date printed on the ChemBag is correctly entered

More details on the lifetime of a replacement part can be opened with **<OK>** .



CONTROLLER	11 Dec 2019	15 03			
503/504 Alyza IQ NH4			Status: IDLE		
ChemBag Reagent A					
Type	R-NH4/1-2A				
expiry date	23 Feb 2020				
Filling level	96 %				
Current use	144 Measurements per day				
Remaining time	43 Day(s) until 23Jan 2020				
Limited by	Measurements				
Attention: The remaining times are only correct if the date of expiry was correctly entered.					
Return with ESC					

figure 4-8 Information on Remaining, detailed view (Tab Remaining)

4.5.3 Information on maintenance activities and calibration procedures (tab *History*)

The Alyza IQ histories provide an overview of the replacement parts installed, the maintenance activities carried out, and the calibration procedures performed.

- *Installed replacement parts*
(list of the replacement parts installed with installation date and the expiry date entered)
- *Calibration history*
(list of the last calibration procedures with the relevant calibration data)
- *Cycle history (Service info)*
(chronological list of performed partial steps on the MPV with evaluation)
- *SystemCheck history (Service info)*
(chronological list of performed System Checks with evaluation)

Installed replacement parts

CONTROLLER	11 Dec 2019	15 17			
S03/S04 Alyza IQ NH4					Status: IDLE
Installed replacement parts					
Part	Installation	Expiry			
MultiPort valve (MPV)	11 Dec 2019				
Reagent A R-NH4/1-2A	11 Dec 2019	25 Aug 2020			
Reagent B R-NH4/1-2B	11 Dec 2019	25 Aug 2020			
Reagent C R-NH4/1-2C	11 Dec 2019	25 Aug 2020			
Standard solution 1 S-NH4/1-0.0	11 Dec 2019	25 Aug 2020			
Standard solution 2 S-NH4/1-16.0	11 Dec 2019	25 Aug 2020			
▼					
Scroll , help , return with ESC					

figure 4-9 Installed replacement parts (tab History / Installed replacement parts)

The list *Installed replacement parts* shows a list of all components that have to be replaced regularly, i.e. when the use-by period has expired. The installation date and expiry date of a component are recorded when the component is installed. These data are documented.

Calibration history The *Calibration history* list shows the last calibration results (see section 4.4.3 Calibration history, 88).

CONTROLLER	11 Dec 2019	11:46	🔒 ⚠️ ⓘ			
S01/S02 Alyza IQ NH4		Status: IDLE				
Calibration history ▶						
Date	Time	Srel	OSType	STD	MR	OK
11 Dec 2019	11:46	1.00	10 A	0/16	2	+
10 Dec 2019	11:46	1.00	11 A	0/16	2	+
09 Dec 2019	11:46	1.00	12 A	0/16	2	?
08 Dec 2019	11:46	1.00	13 A	0/16	2	-
07 Dec 2019	11:46	1.00	0 A	0/16	2	+
06 Dec 2019	11:46	1.02	15 A	0/16	2	+
05 Dec 2019	11:46	1.02	16 A	0/16	2	+
04 Dec 2019	11:46	1.00	0 F	0/16	2	+
03 Dec 2019	11:46	0.98	18 A	0/16	2	+
02 Dec 2019	11:46	0.98	19 A	0/16	2	+
Scroll/Move ⬅️, help ⓘ, return with ➡️						

To display more information, use << >> >>>
 Current calibration data
 Chronological list of the last calibration procedures
 To display explanations and additional information, use

figure 4-10 Calibration history Alyza IQ

The calibration history provides the following information:

- **Date** and **time** of the calibration
- **Srel** (relative slope, referred to a standard slope)
To display the allowed range, use <OK>
- **OS** (Offset in mA, absorbance at concentration 0 mg/l)
Show the allowed range on the display with <OK>
- **Type**
M: Manual calibration
A: Automatic calibration
F: Factory setting
- **STD** (concentration in mg/l of the calibration standards used)
- **MR** (measuring range 1 [low] or 2 [high])
- **OK** (evaluation of the calibration result):
+ successful calibration.
The new calibration data are taken over for measurement.
- calibration unsuccessful. Sensor blocked for measurement.
? : The last valid calibration or factory setting was taken over
- **Abs.** (absorbance standard 1 / standard 2), display with <▶ >

Cycle history (Service info)

In the list *Cycle history (Service info)*, partial steps (cycles) are recorded during the operation of the Alyza IQ. The details of the cycles are used by the service department to diagnose the causes of errors.

SystemCheck history (Service info)

In the list *SystemCheck history (Service info)*, all System Checks that were carried out automatically or manually are recorded. The details of the components checked are used by the service department to diagnose the causes of errors.

4.5.4 More information on the Alyza IQ (tab Info)

In the *Info* tab there is more information on the Alyza IQ, which may be helpful in the case of errors or implausible measured values. The following information is displayed:

- Temperature control (temperature, functioning of the ventilators, heating units, cooling unit)
- Software statuses (control units ACM, ACS, etc.)
- Serial numbers of individual components

CONTROLLER	11 Dec 2019	08 24	🔒	⚠️	📄
S01/S02 Alyza IQ NH4			Status: MEASURE 2		
◀ Maintenance	Status	Remaining	History	Info	
State MultiPort Valve (MPV)				OK	
Status of memory-stick measuring unit...				OK	
Temperature of housing interior				19.3 °C	
Temperature of measuring unit/ACS				19.9 °C	
Temperature of photometer				45.00 °C	
Temperature of control unit/ACM				30.6 °C	
Rel. Humidity control unit/ACM				26 %	
Rel. Humidity measuring unit/ACS				85 %	
Heating of housing interior				0 %	
Heating of measuring unit				0 %	
Photometer heating				26 % ▼	
Select ⬅➡, exit with ESC					

figure 4-11 Info (tab Info)

4.6 Transferring information to a USB memory device via the Alyza IQ

You can save the measurement data of the Alyza IQ via the USB interface of your IQ SENSORNET controller as usual (see system operating manual).

Moreover, other operating data can also be transferred to a USB memory device via the Alyza IQ:

- A selection of important operating data (see section 4.6.1 Transferring to a USB memory device a selection of important operating data, 96)

- Detailed operating data for evaluation by the service department (see section 4.6.2 Transferring detailed operating data to a USB memory device for evaluation by the service department, 96)

4.6.1 Transferring to a USB memory device a selection of important operating data

These operating data provide an overview of important settings and data for the functioning of your Alyza IQ.

- Measurement settings
- Calibration settings
- Calibration data of the last calibration
- Lifetimes of the replacement parts (MPV, ChemBags)

- 1 Plug a USB memory device to the USB interface of your IQ SENSORNET controller (e.g. Terminal/Controller 2020 3G).
- 2 At the terminal, open the tab *Maintenance* in the Alyza menu.
- 3 Select the function, *Save Alyza info file to USB memory device*. Follow the instructions on the display.
- 4 Remove the USB memory device from the USB interface of your IQ SENSORNET controller.
- 5 Connect the USB memory device to the USB interface of a PC and display the file system of the USB memory device.

On the USB memory device there is the folder "AlyzaInfoData" with the info data of the Alyza IQ.

Each time the data are output, a new file with the creation date and creation time in the file name is saved to the folder.

The assignment of the data to an Alyza IQ is secured via the series number of the Alyza IQ in the file name.

4.6.2 Transferring detailed operating data to a USB memory device for evaluation by the service department

The service department can make use of the detailed operating data to analyze and eliminate errors.

- 1 Unscrew the 2 fixing screws of the cover lid of the control unit ACM and remove the cover lid of the ACM.
- 2 If a USB plug is connected to the USB interface next to the "USB0" interface:
Remove this USB plug.

- 3 Plug a USB memory device to the USB interface "USB0".
- 4 At the terminal, open the tab *Maintenance* in the Alyza menu.
- 5 Select the function, *Save service files to USB memory device*. Follow the instructions on the display.
- 6 Remove the USB memory device from the interface "USB0".
- 7 If necessary, re-insert the previously removed USB plug into the unlabeled USB interface.
- 8 Reinsert the cover and fix it with the 2 fixing screws.
- 9 Connect the USB memory device to the USB interface of a PC and display the file system of the USB memory device.

On the USB memory device there is the folder "LogData" with the operating data of the Alyza IQ.
The folder includes several files with the operating data of the Alyza IQ. The assignment of the data to an Alyza IQ is secured via the series number of the Alyza IQ in the file name.
- 10 If requested, send some individual files or the entire folder "LogData" to the service department.

4.7 Software update for the Alyza IQ

With a Software-Update you can always update your Alyza IQ to the latest status of the instrument software.

For the update packet with the current instrument software for the Alyza IQ as well as a comprehensive manual on how to carry out the update, go to www.YSI.com.



The Software-Update for the Alyza IQ is included in the update packet for the IQ SENSORNET.



The software versions of all components can be viewed in the dialog box *List of all components* (see IQ SENSORNET system operating manual).

The Alyza IQ is an IQ SENSORNET component with separate USB interface.

- 1 Download the software update IQ SENSORNET "Update Pack (L1)" and store the directories to a USB memory device.

- 2 Unscrew the 2 fixing screws of the cover lid of the control unit ACM and remove the cover lid of the ACM.
- 3 Plug the USB memory device with the software update IQ SENSORNET "Update Pack (L1)" to the USB interface "USB0".
- 4 On the terminal, switch to the measured value display of the IQ SENSORNET.

NOTE

An interruption of the power supply during the update process can damage your Alyza IQ.

After starting the update process, do not interrupt or cancel the data transmission. Do not interrupt the supply voltage during the update process!





The update takes up to 10 minutes.

- 5 In the service menu, start the software update (component with USB interface).

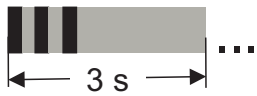
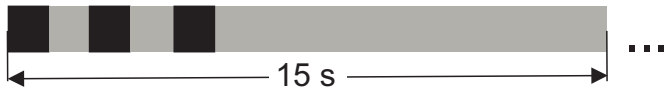

A Software-Update does not change any measurement settings, measurement data or calibration data.

A sequence of beeps indicates the status of the software update.
 The sequence of beeps is repeated until the status is finished automatically or manually:

Sequence of beeps	Explanation	STATUS / Next step
 <p>1 short beep (0.2 secs.) 1 long pause (2.8 secs.)</p>	<p>Software update activated.</p>	<p>UPDATE ACTIVE</p> <ul style="list-style-type: none"> ● Wait for the software update to be completed, e.g. <ul style="list-style-type: none"> – 3 short beeps: SUCCESSFUL – 3 long beeps: ERROR
 <p>1 very long pause during the active update (approx. 1 min), the display is switched off.</p>	<p>The ACM is restarted during a software update.</p>	<ul style="list-style-type: none"> ● Wait for the software update to be continued or canceled. <p>If there is a longer pause (> approx. 3 min) with the display switched off:</p> <ul style="list-style-type: none"> – Switch off the Alyza IQ – Wait for 10 seconds – Switch on the Alyza IQ
 <p>3 short beeps (0.2 s) 2 short pauses (0.2 s) 1 long pause (2 s)</p>	<p>Software updated carried out</p>	<p>UPDATE SUCCESSFUL</p> <ul style="list-style-type: none"> ● Remove the USB memory device. The Alyza IQ automatically restarts.
 <p>3 long beeps (1 s) 2 long pauses (1 s) 1 long pause (10 s)</p>	<p>Software update not successful</p>	<p>ERROR</p> <ul style="list-style-type: none"> ● Remove the USB memory device. The Alyza IQ starts with the old software. ● Check the data on the USB memory device and, if necessary, copy them once again. ● Repeat the software update
 <p>2 long beeps (1 s) 1 long pause (1 s) 1 long pause (12 s)</p>	<p>Software update not complete.</p>	

5 Maintenance and cleaning

5.1 Hazard warnings

Read the chapter 2 Safety instructions, 22 before doing any maintenance work. This is important for your personal safety.

NOTE

The interior of the measuring unit is temperature-controlled to 20 °C (68 °F). With ambient temperatures over 25 °C (77 °F) and high air humidity, condensation water may develop on the cool surfaces and cause damage when the measuring unit is opened.

To avoid damage of the measuring unit due to the formation of condensation water, always wait for the temperature adjustment (function "Prepare to open measuring unit") to be completed before opening the measuring unit.

Hazards due to chemicals

During the regular operation of the Alyza IQ, small quantities of (hazardous) chemicals are used because of the measuring method. The remains of the chemicals are transported out of the Alyza IQ via the drain tubes:

- Return tube (outlet to the sedimentation tank)
- Waste tube (outlet into a collecting container for separate disposal)

For a safe routine operation, the required chemicals are stored in closed, leak-proof ChemBags.

Contact with hazardous chemicals is possible especially in the following situations:

- Contact with waste solutions after measurement
- Contact with open tubes that still contain small amounts of chemicals (e.g. during installation or maintenance work).
- Contact with damaged, leaking ChemBags (e.g. during installation or maintenance work).
- Contact with liquids in the collection tray under the ChemBags (e.g. during installation or maintenance work).

Risks when handling the ChemBags



WARNING

Dangerous chemicals. Improper use of chemicals can cause damage to your health.

Heed the following rules:

- **Read the labels of the ChemBags and follow the safety instructions**
- **Wear protective equipment (lab coat, protective goggles, chemical resistant protective gloves, safety shoes)**

Notes on safely handling the ChemBags

- If a ChemBag was damaged in the transport packaging, e.g. visibly leaked liquid, do not use this ChemBag in the Alyza IQ.
- Make sure you don't damage the ChemBags when unpacking them from the transport packaging.
- Do not use any sharp object when dealing with (or unpacking) the ChemBags.
- If possible, handle the ChemBags gripping only the cap in order not to kink the ChemBags.
- For work done with the locking device of the MultiPort valve open:
Prior to working with the locking device open make sure that the connected ChemBags are safely suspended from the supporting rods, and that they are not pressed or moved while the locking device is open.
- Working with the ChemBags:
Prior to working with any connected ChemBags make sure that the MultiPort valve is inserted and the locking device of the MultiPort valve is closed.

5.2 Opening the locking device of the MultiPort valve ("Before opening: Drain the system")

The MultiPort Valve is the core element for the distribution and dosing of the liquids in the measuring unit. The MultiPort valve is connected to the liquids by exactly positioning the MultiPort valve and pressing it to the seals. The pressing of the MultiPort valve to the seals is done by closing the locking device. Only then is the system sealed at the contact points of the liquids.

**WARNING**

Dangerous chemicals.

Do not open the locking device of the MultiPort valve if the maintenance activities at the measuring unit have not been completed. Leaking chemicals can cause health problems and damage the measuring unit.

Heed the following rules:

- Carry out the *Prepare to open measuring unit* function.
- Carry out the "*Drain the system / All*" function.
- Guide all tubes of the ChemBags over the tube fasteners above the locking device.
- Fix the tubes in the tube fasteners.
- Make sure that the connected ChemBags are safely suspended from the supporting rod, and that they are not pressed or moved while the locking device is open.
- Make sure that the sample tubes (from the overflow vessel to the measuring unit) are fixed in the recesses at the left-hand side of the measuring unit.
- Follow the safety instructions.
- Wear protective equipment (lab coat, protective goggles, chemical resistant protective gloves, safety shoes)



Prior to opening the locking device always check whether the measuring unit was prepared for the opening and whether the system was emptied (e.g. tab *Status* in the Alyza menu).

How to prepare the maintenance of the measuring unit is described in detail with the maintenance of the measuring unit (see section 5.5 Installing / exchanging the ChemBags, MPV, tubes, 109).

Emptying the system via the Alyza menu

With an Alyza IQ ready for operation, empty the system via the Alyza menu.

- 1 Open the *Maintenance / Manual maintenance* menu in the Alyza menu.
- 2 Select the function, *Prepare to open measuring unit*. Follow the instructions on the display. The procedure starts the temperature adjustment of the measuring unit.
- 3 Drain all tubes (*Maintenance / Manual maintenance / Drain the system / All*).



If emptying via the Alyza menu is not possible, carry out the manual emptying (section 5.10 Emptying the system manually, 142).

Opening the locking device

- 4 Put on your personal protective equipment (PPE) and chemical resistant gloves (see section 2.4 Personal protective equipment (PPE), [24](#)).
- 5 Remove the front cover of the measuring unit.
The measuring unit is ready to be opened when the LED of the measuring unit lights up white.
- 6 Using one hand, grip the handle at the upper edge of the front cover of the measuring unit.
- 7 Pull the front cover of the measuring unit somewhat to the front against the resistance.
- 8 Carefully take the front cover out to the front.
Put the front cover down in a clean place.
- 9 Make sure that the connected ChemBags are safely suspended from the supporting rod.
- 10 Guide all tubes of the ChemBags over the tube fasteners above the locking device and fix the tubes in tube fasteners.

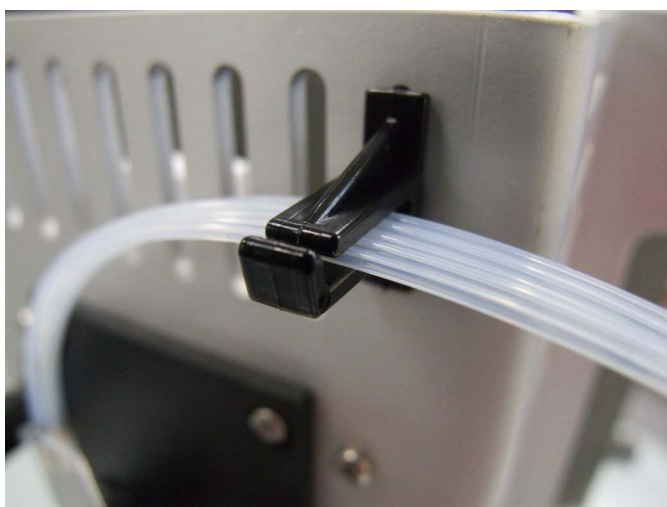

figure 5-1 Tubes in the tube fasteners

- 11 Make sure that the connected ChemBags are safely suspended from the supporting rod, and that they are not pressed or moved while the locking device is open.
- 12 Make sure that the sample tubes (from the overflow vessel to the measuring unit) are fixed in the recesses at the left-hand side of the measuring unit.
- 13 Keep absorbent and lint free paper at hand so you can immediately absorb any small chemicals remains.

- 14 Prepare the locking device of the MultiPort valve (MPV) to be opened (*Maintenance / Manual maintenance / Prepare to open the locking device of the MPV*).
- 15 Confirm that the requirements for the opening are met. When the locking device is ready to be opened, the status LED flashes white. (You can open the locking device of the MultiPort valve without warning sounds.)
- 16 When the status LED flashes white:
Open the locking device of the MultiPort valve (MPV)



Beeps and a red flashing status LED signal that not all requirements for a safe opening of the locking device were met. When the locking device is open, there is the risk of leaking chemicals.

- 17 Immediately place the absorbent, lint free paper onto the MultiPort valve.
- 18 Gently fold down the fluidic interface above the MultiPort valve by hand so that it contacts the paper, and liquid remains are absorbed. The locking device is now safely opened.
- 19 Make sure that the seals of the fluidic interface remain within the interface.



figure 5-2 Removing the liquids remains with absorbent, lint free paper

NOTE

To avoid damage to the measuring unit caused by leaking chemicals, make sure that the following requirements are met while you are working with the locking device open:

- The connected ChemBags are safely suspended from the supporting rod.
- The ChemBags are not pressed or moved.
- The tubes of the ChemBags are fastened in the tube fastening above the locking device.
- The sample tubes (from the overflow vessel to the measuring unit) are fixed in the recesses at the left-hand side of the measuring unit.

20 Carry out any maintenance activities now as necessary.

5.3 Replacement parts, accessories

Only use original replacement parts and accessories. ChemBags are available as sets optimally combined for your application. The combination as sets takes into account the following factors for your application:

- Measured parameter
- Measuring range
- Quantity of liquid
- Stability

By using the sets you avoid any unsuitable combinations of ChemBags. ChemBags are also obtainable individually.

ChemBags

Type	Consumable	Order number
R-Set NH4/1-1	Set of reagents for MR1	827540
R-Set NH4/1-2	Set of reagents for MR2	827541

Type	Consumable	Order number
SC-Set NH4/1-1_0/1	Set of calibration standards and cleaning solutions for MR1	827545
SC-Set NH4/1-1_0/4	Set of calibration standards and cleaning solutions for MR1 / MR2	827546
SC-Set NH4/1-2_0/16	Set of calibration standards and cleaning solution for MR2	827547



Individual ChemBags:
Available on the Internet at www.YSI.com.

Further replacement parts

Type	Replacement parts	Order number
MPV-1	MultiPort valve	827000Y
Syringe Pump Set	Syringe body with holder	827170Y



Further replacement parts and accessories:
Available on the Internet at www.YSI.com.

Accessories (optional)

Type	Accessories	Order number
WF Set	Mounting set for a collection funnel	827187Y
TM	Mounting set for the terminal holder	822000Y
CheckValve	Check valve (for the sample feed tube)	827186Y

The base solutions for chemical cleaning of the filter membrane can be purchased in household or specialist shops, e.g. household hygienic cleaners based on sodium hypochlorite.

For chemical cleaning, see section 5.7.2 Chemical cleaning of the filter plate, 124.

NOTE

*Detergents containing tensides can cause damage.
Therefore, do not use any detergents containing tensides.*

5.4 Overview of the maintenance and cleaning activities

Maintenance activities have to be done at regular intervals on the Alyza IQ. The following maintenance activities can be performed by the operator.

Regular maintenance activities

Regular maintenance		Interval
Measuring unit (simple maintenance activities on site)	Installing/replacing the MultiPort valve (MPV)	Approx. 12 months with a measuring interval of 10 min. Depending on the frequency of the measuring, cleaning or calibrating procedures, the maintenance intervals will be shorter or longer (see section 5.5, ¶ 109)
	Installing / replacing the ChemBags	Approx. 3 - 6 months (MR1), approx. 1.5 - 3 months (MR2), depending on the frequency of the measuring, cleaning and calibration routines (see section 5.5, ¶ 109)
	Check the collection tray under the ChemBags for dryness	When replacing ChemBags or MPV (see section 5.5, ¶ 109, and section 5.5.6, ¶ 117) For logbook messages on MPV leak tightness
	Installing/replacing the tubes on the MultiPort valve (MPV)	12 - 24 months (see section 5.5, ¶ 109)
Measuring unit (complex maintenance activities in the laboratory, after removing the measuring unit)	Installing / replacing the syringe body	Approx. 2 years (see mounting instructions of the syringe body)
	Installing / replacing the tubes of the photometer unit)	As necessary (see mounting instructions of the tubes of the photometer unit)
	Waste collector and waste tube of the measuring unit	6 months (see section 6.2.3, ¶ 154)
Sample inlet, outlet	Clean the overflow vessel and intake line	As necessary (see section 5.7.5, ¶ 128)
	Sample overflow tube	As necessary

Regular maintenance		Interval
	Collection funnel	2 ... 4 months depending on the application
	Return line	
Sample filtration	Sample filtration: Cleaning the filter plate (Filter/PC)	1 ... 4 months depending on the application. If cleaning does not help (see section 5.7.4, 127)
Housing	Cleaning the filter mats at the housing	Depending on contamination (see section 5.8.2, 134)
	Cleaning the housing	As required (see section 5.8.1, 134)
	Bug screen	As necessary

Maintenance activities at the power supply box

Maintenance activities at the power supply box are only required for work at the heat tracing or power cable (see section 5.9 Maintenance activities at the power supply box, [137](#)).

5.5 Installing / exchanging the ChemBags, MPV, tubes

The routine maintenance activities at the measuring unit are included in one procedure (MPV, tubes, ChemBags).



WARNING

**Dangerous chemicals.
Improper use of chemicals can cause damage to your health.**

Heed the following rules:

- **Read the labels of the ChemBags and follow the safety instructions**
- **Wear protective equipment (protective goggles, chemical resistant gloves)**



For all activities at the open measuring unit:

- Note the environmental conditions (see fig. 3.3.1, 27).
- With low ambient temperatures, make sure that the liquids do not freeze while the maintenance activities are carried out. Leave the housing open for as short a time as possible.
- Open the outer housing door far enough so the arrestable brake-stay catches.
- Open the inner housing door far enough so that it touches the outer door. Tilt the angular sheet (at the inside of the outer door) over the upper edge of the inside door.

Maintenance preparation





During the initial commissioning, the install wizard guides you through the maintenance preparation.

Continue with section 5.5.4 Installing the MultiPort valve (MPV) and tubes , 113.

Proceed as follows to carry out maintenance activities of the liquid circle of the Alyza IQ:

- 1 Start the maintenance routine of the Alyza IQ (see section 5.5.1, 110)
- 2 Prepare the maintenance activities (see section 5.5.2, 111)
- 3 Open the measuring unit (see section 5.5.3, 111)
- 4 Check the collection tray under the ChemBags for liquids (see section 5.5.6, 117)
- 5 If required:
Installing the MultiPort valve (MPV) and tubes (see section 5.5.4, 113)

- 6 If required:
Installing the ChemBags (see section 5.5.7,  119)
- 7 Terminating the maintenance routine (see section 5.5.8,  122)

5.5.1 Start the maintenance routine of the Alyza IQ

- 1 In the measured value display, use <▲><▼> to select the Alyza IQ.

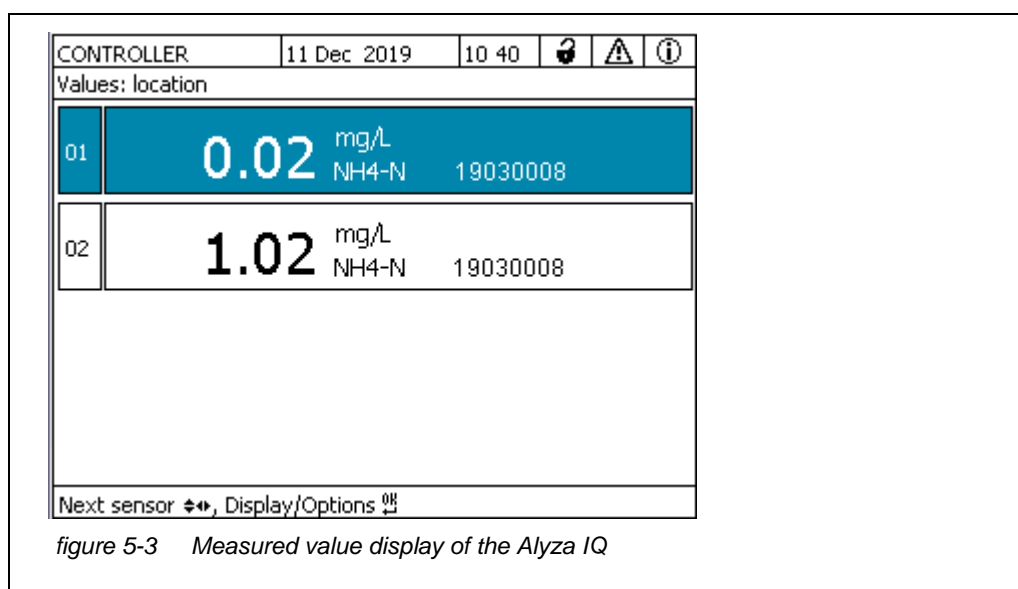

- 2 Using the <C> key, switch to the Alyza menu.
- 3 Using <◀>, switch to the *Maintenance* tab.
- 4 Open the *Wizards* menu.
- 5 Carry out the *Replace MPV/ChemBag, change configuration* function. The menu *Edit list of replacement parts* is open.
- 6 Select the maintenance parts intended for maintenance and continue the wizard.
- 7 Wait until the maintenance wizards allows the opening of the Alyza IQ.



The list of replacement parts does not include exchanging the tubes.

5.5.2 Prepare the maintenance activities

**WARNING**

Dangerous chemicals.
Improper use of chemicals can cause damage to your health.

Heed the following rules:

- Read the labels of the ChemBags and follow the safety instructions
- Wear protective equipment (protective goggles, chemical resistant gloves)



For all activities at the open measuring unit:



- Note the environmental conditions (see fig. 3.3.1,  27).
- With low ambient temperatures, make sure that the liquids do not freeze while the maintenance activities are carried out. Leave the housing open for as short a time as possible.
- Open the outer housing door far enough so the arrestable brake-stay catches.
- Open the inner housing door far enough so that it touches the outer door. Tilt the angular sheet (at the inside of the outer door) over the upper edge of the inside door.

- 1 Put on your personal protective equipment (PPE) and chemical resistant gloves (see section 2.4 Personal protective equipment (PPE),  24).



The list of replacement parts does not include exchanging the tubes.

5.5.3 Open the measuring unit

- 1 Start the maintenance routine of the Alyza IQ (see section 5.5.1,  110)
- 2 Prepare the maintenance activities (see section 5.5.2,  111)
- 3 Open the Alyza IQ.

- 4 Remove the front cover of the measuring unit.
The measuring unit is ready to be opened when the LED of the measuring unit lights up white.

- 5 Using one hand, grip the handle at the upper edge of the front cover of the measuring unit.
- 6 Pull the front cover of the measuring unit somewhat to the front against the resistance.
- 7 Carefully take the front cover out to the front.
Put the front cover down in a clean place.
- 8 Guide all tubes of the ChemBags over the tube fasteners above the locking device and fix the tubes in tube fasteners.

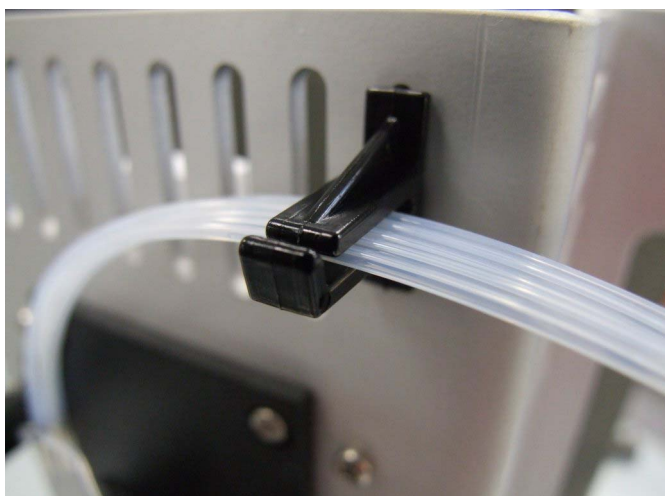



figure 5-4 Tubes in the tube fasteners

- 9 Carry out the maintenance activities in the measuring unit.
or
Complete the maintenance routine (see section 5.5.8,  122).

5.5.4 Installing the MultiPort valve (MPV) and tubes



WARNING

Dangerous chemicals.



Do not open the locking device of the MultiPort valve if the maintenance activities at the measuring unit have not been completed. Leaking chemicals can cause health problems and damage the measuring unit.

Heed the following rules:

- **Carry out the *Prepare to open measuring unit* function.**
- **Carry out the *"Drain the system / All"* function.**
- **Guide all tubes of the ChemBags over the tube fasteners above the locking device.**
- **Fix the tubes in the tube fasteners.**
- **Make sure that the connected ChemBags are safely suspended from the supporting rod, and that they are not pressed or moved while the locking device is open.**
- **Make sure that the sample tubes (from the overflow vessel to the measuring unit) are fixed in the recesses at the left-hand side of the measuring unit.**
- **Follow the safety instructions.**
- **Wear protective equipment (lab coat, protective goggles, chemical resistant protective gloves, safety shoes)**



Prior to opening the locking device always check whether the measuring unit was prepared for the opening and whether the system was emptied (e.g. tab *Status* in the Alyza menu).

- 1 Start the maintenance routine of the Alyza IQ (see section 5.5.1,  110)
- 2 Prepare the maintenance activities (see section 5.5.2,  111)
- 3 Open the measuring unit (see section 5.5.3,  111)

- 4 Make sure that the connected ChemBags are safely suspended from the supporting rod, and that they are not pressed or moved while the locking device is open.
- 5 Make sure that the sample tubes (from the overflow vessel to the measuring unit) are fixed in the recesses at the left-hand side of the measuring unit.
- 6 Keep absorbent and lint free paper at hand so you can immediately absorb any small chemicals remains.

- 7 When the status LED flashes white:
Open the locking device of the MultiPort valve (MPV)



Beeps and a red flashing status LED signal that not all requirements for a safe opening of the locking device were met. When the locking device is open, there is the risk of leaking chemicals.

- 8 Check the MPV for moisture residue.
In case of larger amounts of moisture:
- Check whether there is liquid in the collection tray (see section 5.5.6, [117](#))
 - Check the info and error messages in the logbook.
- 9 Check that all seals are present on the underside of the fluidic interface.
- 10 Place the absorbent, lint free paper onto the MultiPort valve.
- 11 Gently fold down the fluidic interface above the MultiPort valve by hand so that it contacts the paper, and liquid remains are absorbed.
The locking device is now safely opened.



figure 5-5 Removing the liquids remains with absorbent, lint free paper

NOTE

To avoid damage to the measuring unit caused by leaking chemicals, make sure that the following requirements are met while you are working with the locking device open:

- The connected ChemBags are safely suspended from the supporting rod.
- The ChemBags are not pressed or moved.
- The tubes of the ChemBags are fastened in the tube fastening above the locking device.
- The sample tubes (from the overflow vessel to the measuring unit) are fixed in the recesses at the left-hand side of the measuring unit.

- 12 For initial installation of a MultiPort valve:
If necessary, remove from the fluidic interface of the MultiPort valve the blind plugs required for the tube connectors of the MultiPort valve.
To do so, use the special tool in the base of the measuring unit.
- 13 When replacing individual tubes on the MultiPort valve:
Unscrew any old tubes from the fluidic interface of the MultiPort valve.
To do so, use the special tool in the base of the measuring unit.
- 14 When exchanging the MultiPort valve (MPV):
Remove the MultiPort valve.



The tubes of the MultiPort valve can be exchanged individually or as a set:
In the delivery condition, the tube set is already mounted.

- 15 Only when exchanging the MultiPort valve (MPV):
Insert the new MultiPort valve (MPV).
- 16 Connect the tubes to the fluidic interface of the MultiPort valve.

NOTE

Damaged tubes may leak.
Folded or knotted tubes hamper the transport of the liquids.
The tubes must not be damaged, folded or knotted.

Color coding	Connection of
Green (reagent)	MPV - ChemBag R
Orange (calibration standard)	MPV - ChemBag S
Blue (cleaning solution)	MPV - ChemBag C

- 17 Screw the new tubes onto the fluidic interface of the MultiPort valve. Use the special tool for this.
- 18 If not yet done:
Remove the absorbent paper from the MultiPort valve (MPV).
- 19 Close the locking device of the MultiPort valve (MPV)
- 20 Carry out further maintenance activities in the measuring unit.
or
Complete the maintenance routine (see section 5.5.8, 122).

5.5.5 Remove the ChemBags for maintenance activities

- 1 Start the maintenance routine of the Alyza IQ (see section 5.5.1, 110).
- 2 Prepare the maintenance activities (see section 5.5.2, 111).
- 3 Open the measuring unit (see section 5.5.3, 111).

NOTE

To avoid damage to the measuring unit caused by leaking chemicals, make sure that the following requirements are met while you are working with the ChemBags:

- *The MultiPort valve is inserted.*
 - *The locking device of the MultiPort valve is closed.*
- 4 Remove the empty ChemBags from the supporting rod one by one.

- 5 Turn the ChemBags so that the valve points upward. Suspend the tubes of the empty ChemBags from the tube grooves at the photometer unit so that the ChemBags are suspended downwards from the tubes.

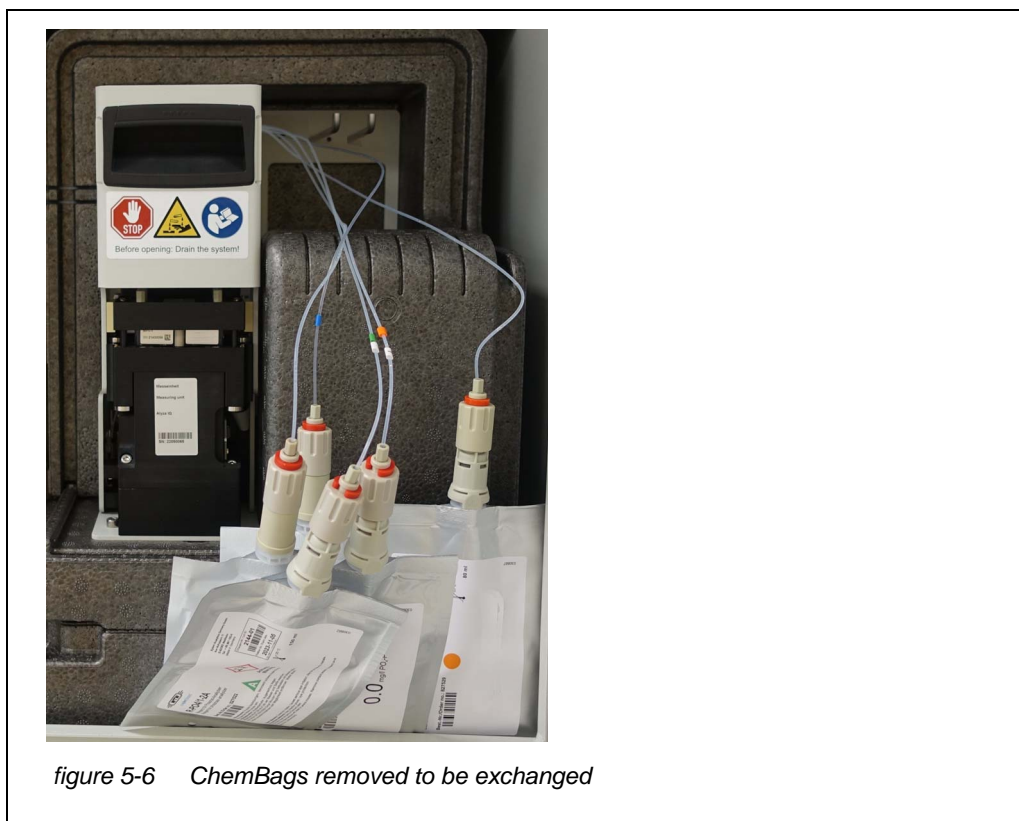

figure 5-6 ChemBags removed to be exchanged

- 6 Check the collection tray under the ChemBags for moisture (see section 5.5.6, [117](#)).

5.5.6 Check the collection tray under the ChemBags for liquids

- 1 Start the maintenance routine of the Alyza IQ (see section 5.5.1, [110](#)).
- 2 Prepare the maintenance activities (see section 5.5.2, [111](#)).
- 3 Open the measuring unit (see section 5.5.3, [111](#)).
- 4 Remove the ChemBags for maintenance activities (see section 5.5.5, [116](#))

- 5 Check the collection tray under the ChemBags for liquids.



When the measuring unit is installed, the collection tray under the ChemBags cannot be seen.

Indications of liquid in the collection tray can be detected, for example, with the camera of a smartphone.

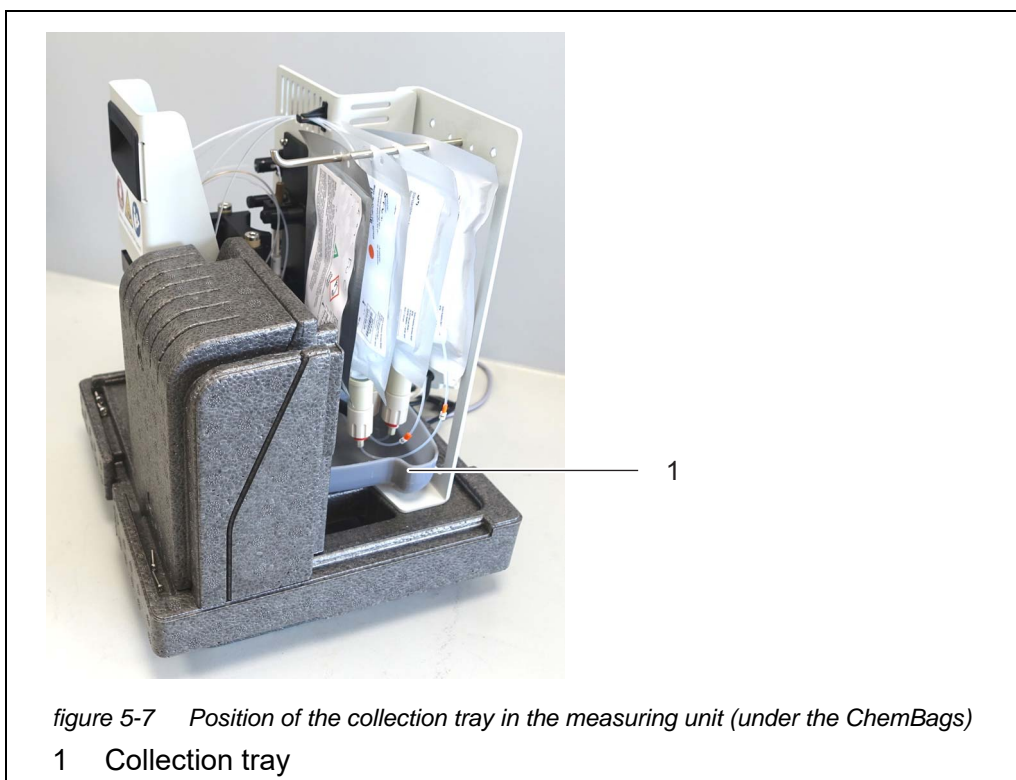

figure 5-7 Position of the collection tray in the measuring unit (under the ChemBags)

1 Collection tray

- 6 If there is liquid in the collection tray:
 - Check the ChemBags for moisture and damage.
 - Check the drain tube from the MPV to the collection tray for moisture.
 - Dry the collection tray
 - For larger quantities of liquid:
Draw up liquid e.g. with a syringe and dispose of it.
 - With little moisture:
Absorb the moisture with an absorbent cloth and dispose of it.
 - In case of leaking or defective maintenance parts:
 - Schedule the replacement of leaking parts via the maintenance routine in the Alyza menu.
 - Schedule the replacement of the leaking ChemBag via the maintenance routine in the Alyza menu (see section 5.5.7, [119](#))
 - Check the MPV for moisture (see section 5.5.4, [113](#))
 - Check the log book messages.

- 7 Carry out further maintenance activities in the measuring unit.
or
Complete the maintenance routine (see section 5.5.8, [122](#)).

5.5.7 Installing the ChemBags

NOTE

To avoid damage to the measuring unit caused by leaking chemicals, make sure that the following requirements are met while you are working with the ChemBags:

- *The MultiPort valve is inserted.*
- *The locking device of the MultiPort valve is closed.*

- 1 Start the maintenance routine of the Alyza IQ (see section 5.5.1, [110](#)).
- 2 Prepare the maintenance activities (see section 5.5.2, [111](#)).
- 3 Open the measuring unit (see section 5.5.3, [111](#)).
- 4 Remove the ChemBags for maintenance activities (see section 5.5.5, [116](#)).
- 5 Check the collection tray under the ChemBags for liquids (see section 5.5.6, [117](#)).

- 6 Unscrew the coupling of the tube from the ChemBag connector.
- 7 Unscrew the protection cap of the ChemBag to be connected. The ChemBag connector points upward.
- 8 Screw the protective cap onto the connector of the empty ChemBag.



The ChemBags with the longest stability and lifetime do not have to be exchanged often. Suspend them first from the supporting rod and slide them to the rear.

- Cleaning solution 2 (C-... 2),
- Cleaning solution 1 (C-... 1),
- Standard 2 (S-...x)
- Standard 1 (S-...y)
- Reagent C (R-...C)
- Reagent B (R-...B)
- Reagent A (R-...A)

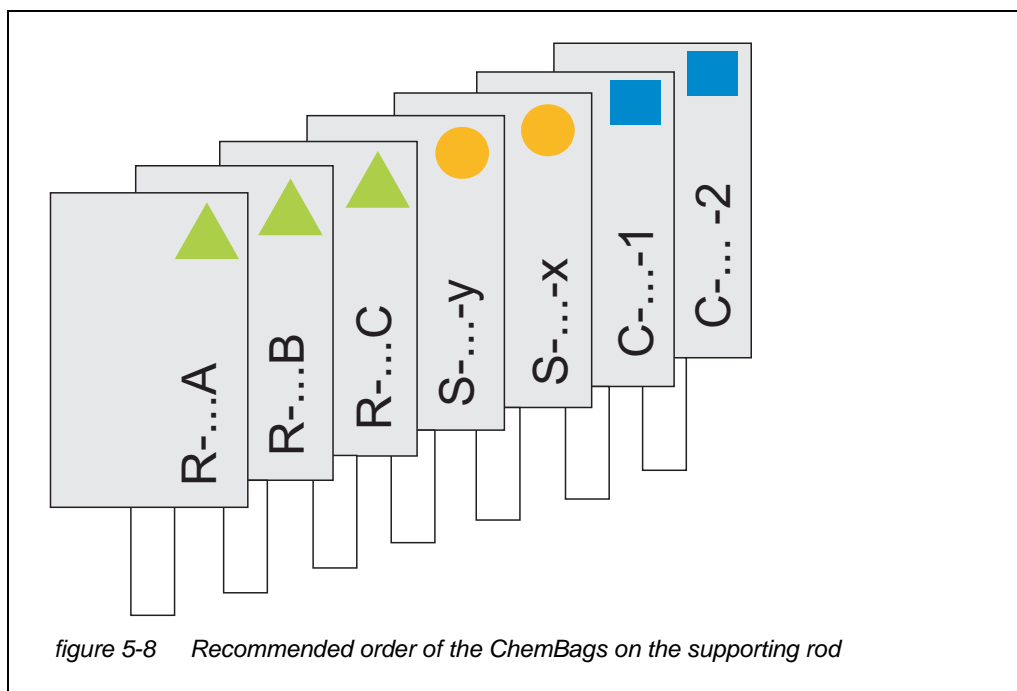

- 9 Screw the coupling of the tube tightly onto the connector of the new ChemBag.
Make sure that the codings of the ChemBag and tube agree (symbol, color, number).

NOTE

Damaged ChemBags may leak.

To avoid damage, the ChemBags must not be folded near the connector. Hold the ChemBags by the connector, with the connector facing upwards. To suspend the ChemBags from the supporting rod: Carefully turn the ChemBags upside down, without folding the ChemBags or tubes.

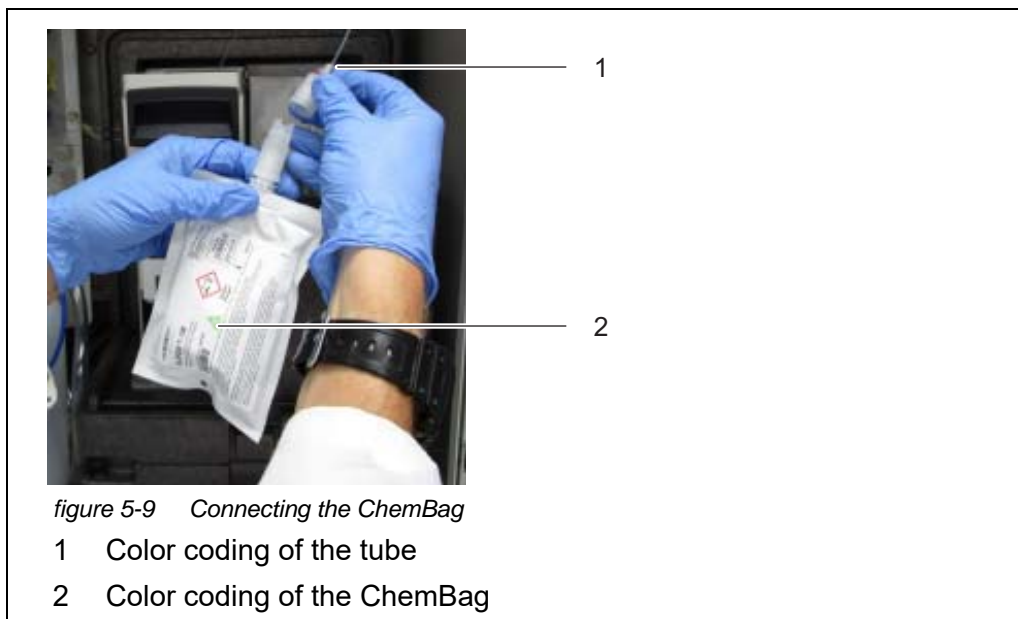

- 10 Carefully turn the ChemBag upside down. The connector points downward.
- 11 If necessary, slightly knock on the connector of the ChemBag to remove any small bubbles from the connector.
- 12 Suspend the ChemBag from the supporting rod.
- 13 Connect all selected ChemBags
 - Measuring range 1: 2 cleaning solutions (blue)
 - Measuring range 2:
 - 1 cleaning solution (blue) or
 - 2 cleaning solutions (blue) for measuring media with a total hardness > 1.3 mmol/l (7.3 °dH)
 - 2 standard solutions (orange)
 - high concentration at connector S2
 - low concentration at connector S1
 - 3 reagent solutions (green)
- 14 For each ChemBag, enter the expiry date and, if necessary, the filling level (for used ChemBags) on the display.

- 15 Guide all tubes of the ChemBags over the tube fasteners above the locking device and fix the tubes in the tube fasteners.



The Alyza IQ has an extra counter for each ChemBag (see section 1.3.3 ChemBags, 15).

When delivered, the counters are set to 100 %.

- 16 Carry out further maintenance activities in the measuring unit.
or
Complete the maintenance routine (see section 5.5.8, 122).

5.5.8 Terminating the maintenance routine

- 1 After maintenance activities at the measuring unit:
 - Hang the ChemBags back onto the supporting rod (see section 5.5.7, 119).
 - Close the front cover of the measuring unit and the doors of the Alyza IQ.
- 2 Follow the maintenance wizard.
Carry out the *OK + START + Switch off maintenance condition* function.
Wait until the maintenance wizard has finished.
Measurement is restarted and the measured value is displayed in the measured value display after approx. 10 minutes.
- 3 After installing ChemBags with reagents:
 - Calibrate the measuring system
(Alyza menu / tab *Maintenance / Manual maintenance / Calibrate (2-point)*)
 - Carry out the *START Alyza IQ* function. Measurement is started and the measured value is displayed in the measured value display after approx. 10 minutes.
 - Carry out the *Switch off the maintenance condition* function.

5.6 Changing the measuring range

During the initial installation you have configured the Alyza IQ for measurements in a small (MR1) or large measuring range (MR2).

You can change the measuring range at any time. Changing the measuring range is done by a guided exchange of all reagents and, if necessary, the standards.

The guided exchange of the measuring range is started in the Alyza menu / tab *Maintenance / Wizards / Prepare to change the measuring range*.

You are guided through the exchange of the ChemBags for reagents and standards, just like when you are exchanging the ChemBags (see section 5.5 Installing / exchanging the ChemBags, MPV, tubes,  109).

5.7 Cleaning the sample filtration and sample feed



Cleaning of the filter module, see the following documents:

- Mounting instructions for the filter module (FM/PC)
- Alyza IQ - short instructions for cleaning the filter membrane module (included in the scope of delivery of the Alyza IQ)

5.7.1 Mechanical cleaning of the filter plate

The time when to clean the filter plate can be determined empirically based on the negative pressure display on the filtration pump.

- A pulsing negative pressure manometer suggests a normal operating condition of the filtration unit.
- With a delivery height of approx. 2 m and a new filter plate, the negative pressure is approx. -0.3 bar.
Every meter of delivery height increases the negative pressure by approx. -0.1 bar.
If the negative pressure increases by a further -0.3 ... -0.4 bar with time, the filter plate is covered with solid matter from the sample and has to be cleaned.
- If, after the mechanical cleaning, there is still negative pressure, a chemical cleaning is required, or the intake line may be blocked.

NOTE

Dirt particles and contamination in the sample line can block the valves of the measuring unit.

During the cleaning activities, make sure that no dirt particles get into the open tube ends or the connector of the filter module.

Protect the open tubes and connectors during the cleaning activities, e.g. with blind plugs.

Maintenance interval	2 to 4 months, depending on the application
Preparations	1 Stop the Alyza IQ with the function, <i>STOP Alyza IQ</i> . The maintenance condition is automatically activated in the IQ SENSORNET for the Alyza IQ.

- 2 Switch off the filtration pump with the Stop key.
- 3 Pull the filtration unit out of the basin or channel.
 - The filter module does not have to be separated from the guide slide.
 - Do not unplug the sample line.
 - Do not dismount the filter plate from the frame.
- 4 Rinse off of the filtration unit any gross contamination with low water pressure (e.g. with a watering can or wash bottle).
- 5 Then carefully remove the coating from the filter plate using a soft special brush. Normally the brownish coating can well be seen coming off while the lighter surface of the filter plate is appearing.

NOTE

The filter plate is easily damaged. Never touch the filter plate with sharp-edged objects or place any objects on it.

Pressure on the filter plate may only be applied from the outside. No counter-pressure may build up through the intake line.

Do not press the special brush onto the surface of the filter plate too firmly and do not change the moving direction of the brush (do not scrub!).



If the contamination cannot be removed with the mechanical cleaning, carry out the chemical cleaning (see section 5.7.2 Chemical cleaning of the filter plate, 124).

- 6 After cleaning, check both sides of the filter plate for damage.
 - 7 Thoroughly clean the special brush under running water, dry it and store in a dust free place till the next use.
 - 8 Remount and secure the cleaned filter module on the slide.
 - 9 Submerge the filtration unit in the basin or channel.
 - 10 Switch on the filtration pump with the Start key.
- Restarting the measuring operation**
- 11 Restart the Alyza IQ and switch off the maintenance condition at the IQ SENSORNET.

5.7.2 Chemical cleaning of the filter plate

Chemical cleaning is recommended if mechanical cleaning no longer achieves any significant improvement, i.e. the negative pressure on the manometer no longer decreases significantly after mechanical cleaning.

In this case, the filter plate is blocked. The blockage is mostly organic and can only be removed by chemical cleaning.

The chemical cleaning is carried out with the aid of a suitable container (Filter-CL) for the cleaning bath. The amount of cleaning solution required depends on the shape and size of the cleaning container.

Cleaning solution In most cases, organic blockages can easily be removed with an aqueous sodium hypochlorite solution (chlorine bleaching agent, NaClO, 1 % active chlorine). In some cases, NaOH 4 % (sodium hydroxide) has proven effective. In case of calcification, diluted acetic acid (max. 10 % acetic acid) or diluted citric acid (max. 10 % citric acid) is recommended.

NOTE

High temperatures damage the material of the filter. Use acidic cleaning solutions only in the temperature range 5°C...35°C.

Preparing the cleaning solution

The cleaning solution can be made from different detergent concentrates by diluting with water. A selection of possible detergent concentrates is given in the section 5.3 Replacement parts, accessories, 105.

Prepare the cleaning solution according to the following table. It can be mixed in the cleaning container.

Base solution	Preparation instructions	Yield
Household hygienic cleaner based on sodium hypochlorite	Add so much water to 1.5 l hygienic cleaner that the volume is 6 l	6 l
Techn. sodium hypochlorite solution (13 % active chlorine)	Add so much water to 300 ml solution that the volume is 5 l	5 l



WARNING

Dangerous chemicals.

Improper use of chemicals can cause damage to your health.

Heed the following rules:

- **Read the labels of the ChemBags and follow the safety instructions**
- **Wear protective equipment (lab coat, protective goggles, chemical resistant protective gloves)**

Pre-cleaning

- 1 Prior to each chemical cleaning, pre-clean the membrane with the special brush and rinse it with water (see section 5.7.1 Mechanical cleaning of the filter plate, 123).
- 2 Dismount the filter unit from the slide.
- 3 Dismount the intake line from the filter unit.

- 4 Protect the filter plate against any contamination coming in (e.g. by closing the connection adapter for the intake line).
- 5 Dismount the filter plate (see section 5.7.4 Replacing the filter plate of the sample filtration, [127](#)).
- 6 Close the connector of the filter unit and the open intake line with blind plugs to that no contamination can get into the filter.



The chemical cleaning of the filter plate may take some time. Use a replacement filter module (FM/PC) during the cleaning process to keep the downtime of the Alyza IQ as short as possible.

Chemical cleaning

- 7 Completely submerge the filter module with the installed filter plate in the cleaning container filled with the cleaning solution.
 - Start with a reaction time of 30 minutes.
 - Watch the cleaning success and extend the reaction time as necessary.
- 8 After the chemical cleaning, rinse the filter module with clean water.



Even a filter plate that is supposedly irreversibly blocked may be restored by leaving it in the cleaning solution for a longer period of time and then rinsing it several times.

Restarting operation

- 9 After cleaning, check both sides of the filter plate for damage.
- 10 Remount the filter plate (see section 5.7.4 Replacing the filter plate of the sample filtration, [127](#)).
or
Store the cleaned filter plate (see section 5.7.3 Storing a used and cleaned filter plate, [126](#)).

5.7.3 Storing a used and cleaned filter plate

Proceed as follows to store the filter plate:

- 1 Clean the filter plate mechanically.
- 2 Clean the filter plate chemically.
- 3 Rinse the filter plate under flowing tap water.

- 4 To protect it against drying out, store the filter plate in the Filter-CL cleaning container or in a sealed plastic bag.



Prior to each use, soak the filter plate in tap water.
If the filter plate has dried out, soak it in tap water for several hours.

5.7.4 Replacing the filter plate of the sample filtration

NOTE

The filter plate is easily damaged. Never touch the filter plate with sharp-edged objects or place any objects on it.

Maintenance interval

As necessary, if cleaning does not help.
Proceed as follows to exchange the filter plate:

Dismounting the filter plate

- 1 Stop the Alyza IQ with the function, *STOP Alyza IQ*. The maintenance condition is automatically activated in the IQ SENSORNET for the Alyza IQ.
- 2 Switch off the filtration pump with the Stop key.
- 3 Pull the filtration unit out of the basin or channel.
 - Do not separate the filter module from the guide slide.
 - Do not dismount the filter plate from the frame.
- 4 Clean the filtration unit.
- 5 Dismount the filter module from the guide slide.
- 6 Unscrew the V4A countersunk screws of the frame (12 hexagon sockets).
- 7 Remove the used filter plate.
- 8 Clean the frame.



Cleaning of the filter plate, see

- section 5.7.1 Mechanical cleaning of the filter plate, [123](#)
- section 5.7.2 Chemical cleaning of the filter plate, [124](#)

Remounting the filter plate

- 9 Insert a new filter plate in the lower frame part.
- 10 Place the upper frame part onto the lower frame part with the built-in filter plate.

- 11 Insert the V4A countersunk screws and tighten them by hand. The fixing ring and lower part of the housing must be pressed together and flush (without gap).
- 12 Remount and secure the cleaned filter module on the slide.
- 13 Submerge the filtration unit in the basin or channel.
- 14 Switch on the filtration pump with the Start key.

Restarting the measuring operation

- 15 Restart the Alyza IQ and switch off the maintenance condition at the IQ SENSORNET.

5.7.5 Cleaning the sample feed, overflow vessel and outlet

The intake line takes the sample liquid from the filter module to the filtration pump. The sample feed tube goes from the filtration pump to the overflow vessel. From time to time it can be required to clean the intake line, sample feed tube and overflow vessel.

fig. 5-10, 128 shows the intake line (blue, ID 2mm; OD 4 mm) in the Alyza IQ.

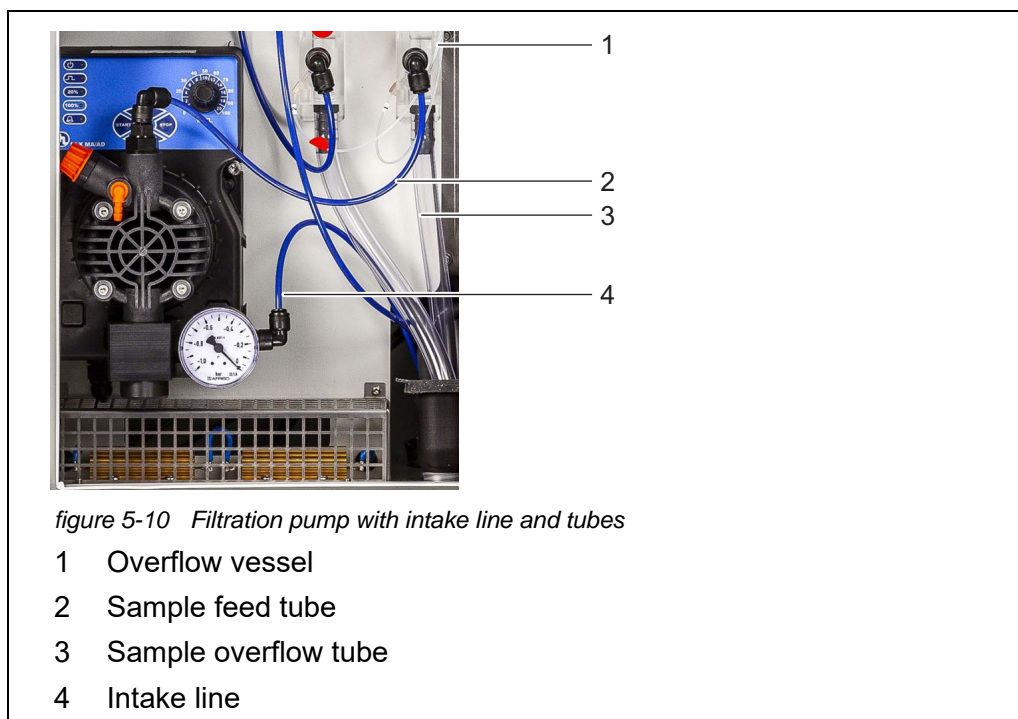
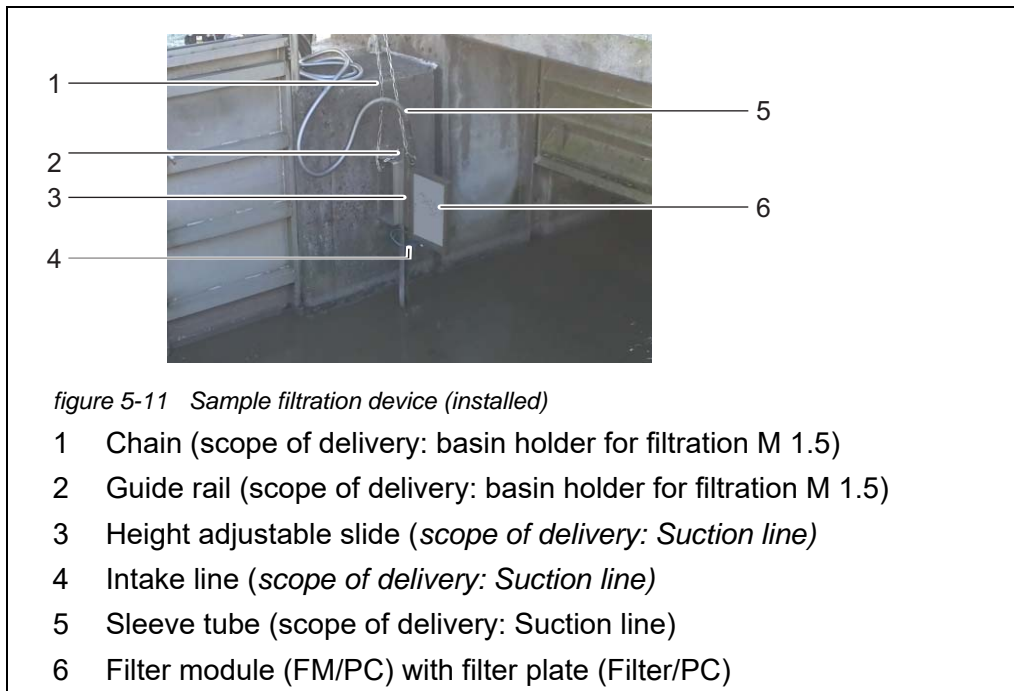



fig. 5-11, 129 shows the intake line on a mounted filter module in a sedimentation tank.





WARNING
Dangerous chemicals.
Improper use of chemicals can cause damage to your health.
Heed the following rules:

- **Read the labels of the ChemBags and follow the safety instructions**
- **Wear protective equipment (lab coat, protective goggles, chemical resistant protective gloves)**

Maintenance interval As required.
 Proceed as follows to clean the intake line:

- Starting the maintenance routine of the Alyza IQ**
- 1 In the measured value display, use <▲ ><▼ > to select the Alyza IQ.

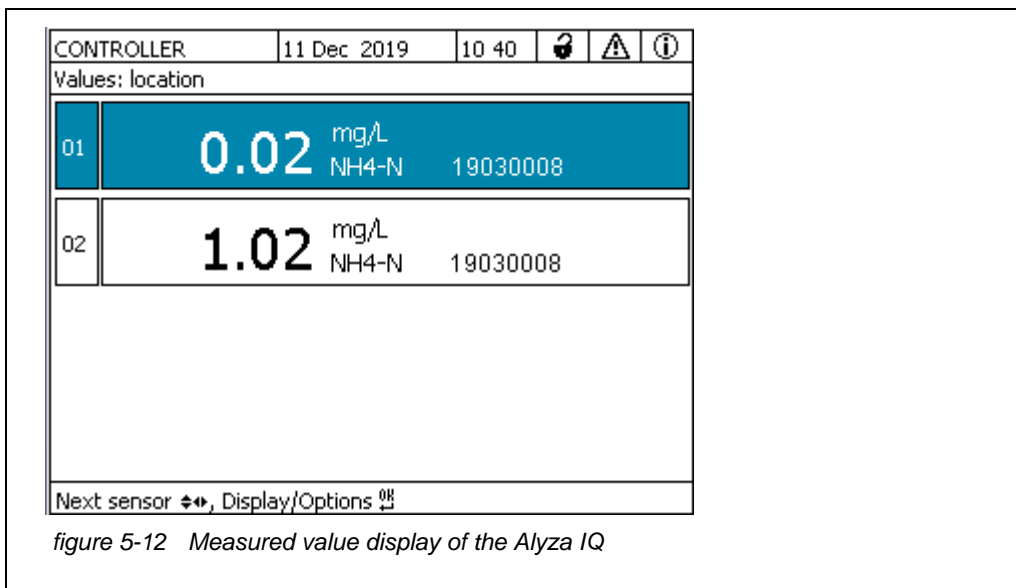

- 2 Using the <C> key, switch to the Alyza menu.
- 3 Using <left>, switch to the Maintenance tab.

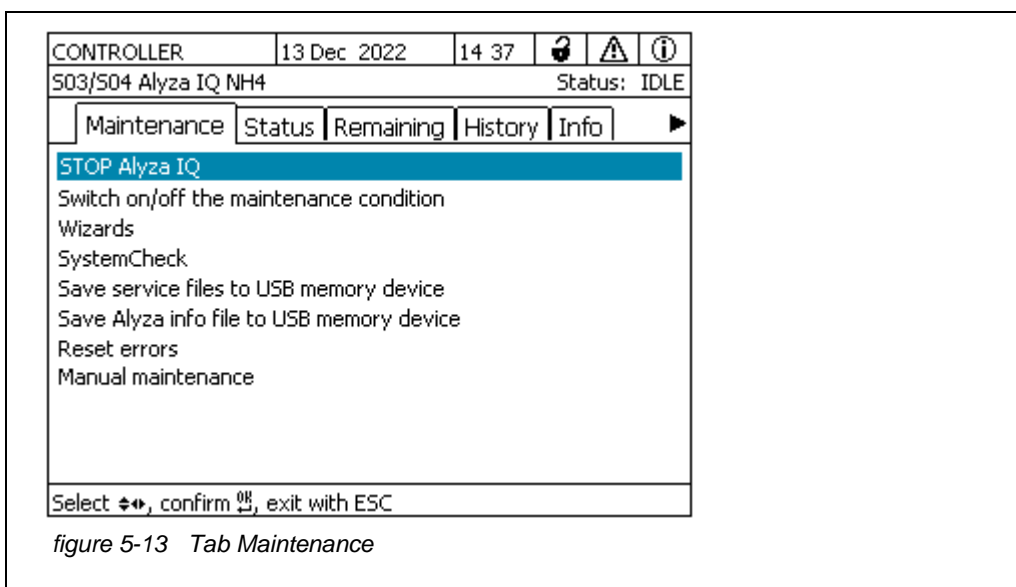

- 4 Carry out the STOP Alyza IQ function to stop the running operation.
- 5 Confirm the function to stop the running operation. The maintenance condition is automatically activated in the IQ SENSORNET for the Alyza IQ.

Carrying out maintenance activities



WARNING

Dangerous chemicals.

Improper use of chemicals can cause damage to your health.

Heed the following rules:

- **Read the labels of the ChemBags and follow the safety instructions**
- **Wear protective equipment (protective goggles, chemical resistant gloves)**



For all activities at the open measuring unit:

- Note the environmental conditions (see fig. 3.3.1, 27).
- With low ambient temperatures, make sure that the liquids do not freeze while the maintenance activities are carried out. Leave the housing open for as short a time as possible.
- Open the outer housing door far enough so the arrestable brake-stay catches.
- Open the inner housing door far enough so that it touches the outer door. Tilt the angular sheet (at the inside of the outer door) over the upper edge of the inside door.

- 6 Put on your personal protective equipment (PPE) and chemical resistant gloves (see section 2.4 Personal protective equipment (PPE), 24).

Preparations

- 7 Switch off the filtration pump with the Stop key.
- 8 Keep ready a container to collect the contents of the overflow vessel.
- 9 Empty the sample tube (Alyza menu / tab *Maintenance / Manual maintenance / Drain the system / Sample xxx*)
- 10 Unscrew the sample tube from the overflow vessel.
- 11 Open the quick coupling of the sample feed tube on the overflow vessel and let the contents of the overflow vessel drain into the container.
- 12 Remove the overflow vessel from the Alyza IQ.

Cleaning

- 13 Open the lid of the overflow vessel.
- 14 Clean the overflow vessel and lid with a brush, water, descaler or detergent. Subsequently, thoroughly rinse the overflow vessel with water to remove any detergent residues.

NOTE

Detergents containing alcohol will damage the overflow vessel.

- 15 If necessary: exchange or clean the filter plate (see section 5.7.1 Mechanical cleaning of the filter plate,  123).
- 16 Provide a container of cleaning solution for the intake line and sample feed tube.

NOTE

Acids as cleaning agents damage individual components of the sample feed and sample inlet (Requirements of the test sample (by the filtration system) see section 8.2).

Recommended minimum amount of cleaning fluid:

Length of intake line	Minimum quantity of cleaning solution
5 m	≥ 30 ml
10 m	≥ 50 ml
20 m	≥ 100 ml

- 17 Disconnect the intake line from the filter module and put it in a container with cleaning solution (recommendation: see section 5.3 Replacement parts, accessories,  105).
- 18 Insert the end of the sample feed tube into a bottle (≥ 0.5 l) or another suitable container.
- 19 Secure the bottle and sample feed tube.

**WARNING**

Dangerous chemicals.

Wear protective equipment (lab coat, protective goggles, chemical resistant protective gloves)

Risk of splashing!

During operation, the filtration pump can develop considerable pressure. Therefore, absolutely heed the following instructions:

- **Fix the sample intake tube so that the pressure surges of the filtration pump will not make it come out of the bottle.**
- **Cover the bottle so that no cleaning solution can splash out due to the pressure surges.**
- **Bring the bottle into a stable position and fix it if necessary.**
- **If necessary, test the arrangement with tap water first.**

- 20 Switch on the filtration pump with the Start key.
Cleaning solution is drawn in through the intake line until it flows into the bottle at the open line end. Leave the filtration pump switched on until the minimum quantity (see  132) has been drawn in from the container with cleaning solution.
If necessary, increase the percent setting for the pump performance at the filtration pump.
- 21 Switch off the filtration pump with the Stop key; allow the cleaning solution to take effect (altogether approx. 10 min). During this time, occasionally start/stop the filtration pump so the cleaning solution in the intake line is moved towards the bottle.
- 22 When doing so, check the filling level of the bottle to keep the solution from overflowing. If necessary, empty the bottle (dispose of the cleaning solution properly).
- 23 Switch off the filtration pump with the Stop key.
- 24 Reconnect the intake line to the filter module and reinstall the filter module in the sample.
- 25 Switch on the filtration pump with the Start key and let it pump for some time (at least 5 - 10 min, depending on the length of the intake line) with approx. 60% capacity to completely remove all the cleaning solution from the filter plate and intake line. This can normally be recognized by the clear sample liquid that comes out of the line. If necessary, set the percent setting for the pump capacity to the previous value.
- 26 Switch off the filtration pump with the Stop key.
- 27 Reinstall the overflow vessel in the Alyza IQ.
- 28 If necessary: Clean the collection funnel for the sample return and the return line with a brush and water.

NOTE

Make sure that the liquids in the collection funnels can drain off freely. A blocked collection funnel can cause the liquids to overflow into the housing of the Alyza IQ. Liquids can cause damage to the housing and electrical components.

- 29 Mount the sample overflow tube to the collection funnel for the sample overflow.
- 30 Screw the sample feed tube to the overflow vessel.
- 31 Re-connect the sample tube to the overflow vessel.
- 32 Remove the container that held the cleaning solution. Dispose of the remainders of the cleaning liquid properly.
- 33 Switch on the filtration pump with the Start key.

- 34 Leave the filtration pump to work for some time to completely remove the detergents.
- 35 Fill the sample tube (*Maintenance / Manual maintenance / Fill the system / Sample xxx*)
- Restarting the measuring operation** 36 Restart the Alyza IQ and switch off the maintenance condition at the IQ SENSORNET.

5.8 Maintenance activities at the housing

5.8.1 Cleaning the housing of the Alyza IQ

- Outside** Clean the outside of the housing with a brush, water, and dish-washing solution.
- Inside** Clean the inside with a moist (not dripping) cloth, water, and dish-washing solution.

5.8.2 Changing the filter mats

The filter mats are in front of the ventilation grids (under the housing lid and on the underside of the housing).

The ventilators are behind the ventilation grids. The filter mats can thus be exchanged riskless even during operation.

Depending on contamination

**Maintenance interval
Upper filter mat**

- 1 Remove both front screws on the housing lid.
- 2 Open the housing lid upward and fix it with the bearer (see fig. 5-14,  135).

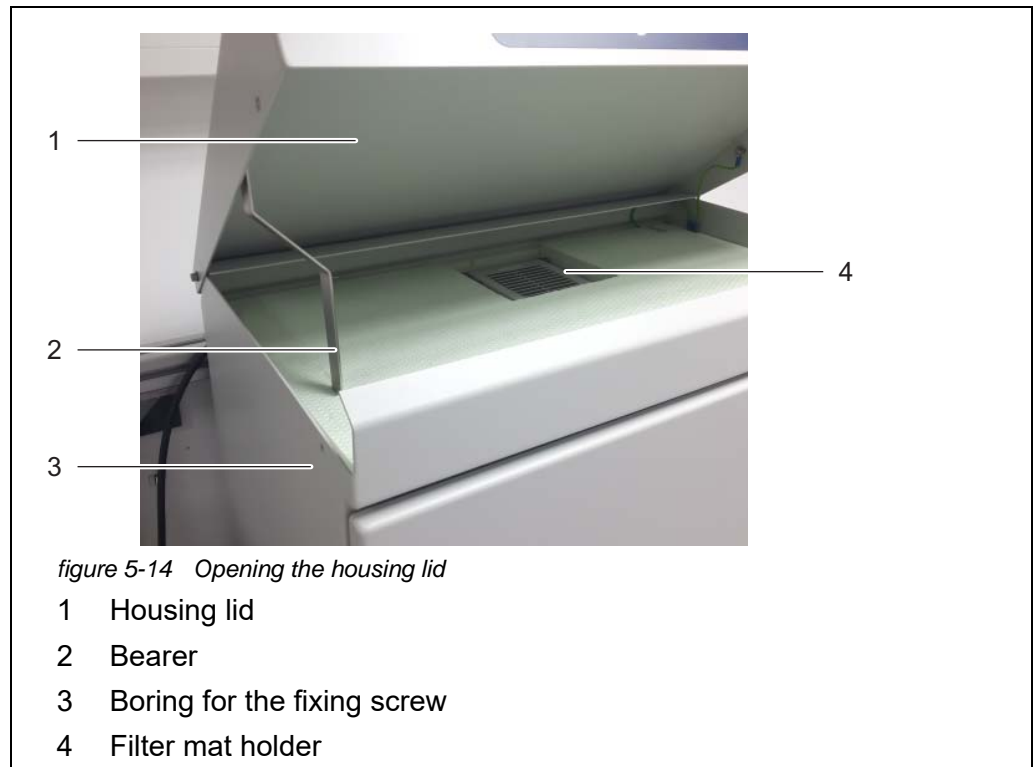

- 3 Open the upper filter mat holder with the aid of a screwdriver by levering it off and exchange the upper filter mat (see fig. 5-15, 135).

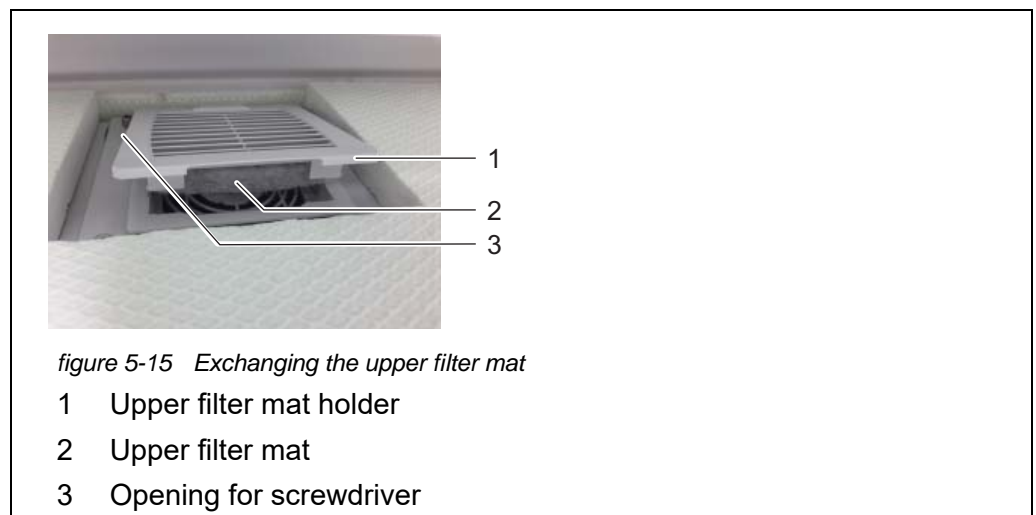

- 4 Press the upper filter mat holder shut again.
- 5 Fold the bearer and close the housing lid.
- 6 Screw the housing lid tight with the two screws.

Lower filter mat

- 7 Position yourself under the Alyza IQ housing.
- 8 Open the lower filter mat holder and exchange the filter mat as done with the upper filter mat holder.

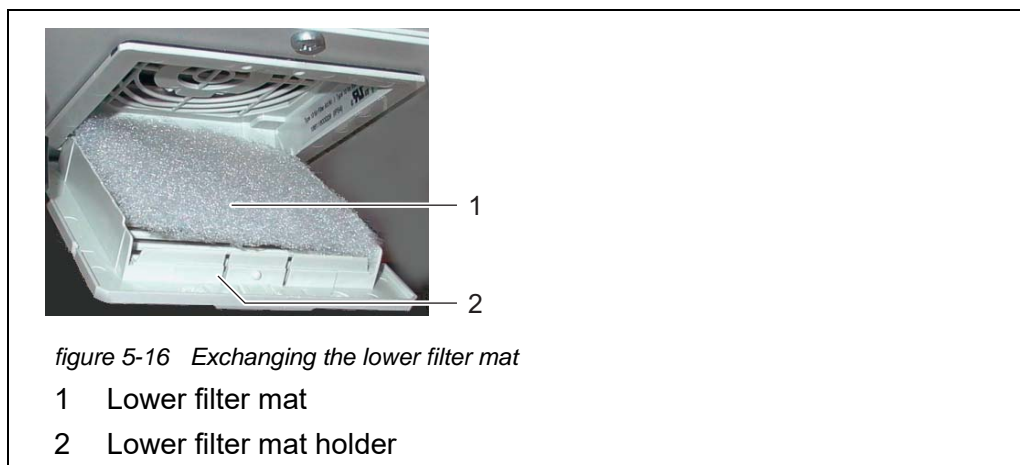

- 9 Close the lower filter mat holder again.

5.8.3 Checking the temperature control

For correct measured values, it is required to control the temperature of some areas of the Alyza IQ.

The temperature control is automatically and regularly checked by the function *SystemCheck* (see section 5.11). You can start the *SystemCheck* function also manually (Alyza menu, tab *Maintenance / SystemCheck*).

The Alyza IQ has 3 areas that are temperature-controlled differently:

Range	Temperature control
Housing inside	+5 ... +40 °C (+41 ... +104 °F)
Measuring unit	20 °C (68 °F)
Photometer unit	45 °C (113 °F)

Heating units, a ventilator and a cooling unit are used to control the temperature of the areas.

The correct temperature control is continuously and automatically monitored for each area in the Alyza IQ.

If an area of the Alyza IQ is not within the specified range, a message appears in the log book. If the deviation from the specified range is great, the Alyza IQ is automatically stopped. The error is documented by an error message in the log book.

You can check very easily and at any time the current status of the temperature control in the Alyza menu / tab *Info*. All temperatures (temperature inside the housing, temperature within the measuring unit) and the operating condition of the ventilators, heating and cooling unit are documented.



5.9 Maintenance activities at the power supply box



WARNING

If the power supply is connected incorrectly, there may be danger to life from electric shock.

Pay attention to the following points during installation:

- The power supply box may only be connected to the power supply by a qualified electrician.
- The power supply box may only be connected to the power supply when it is not carrying any voltage.
- The power supply must fulfill the specifications given on the nameplate and in chapter 8 Technical data,  168.
- The power supply of the heat tracing must fulfill the specifications given on the heat tracing (240 VAC or 120 VAC).
- To operate a heat tracing line, a fault current protection switch (ground fault circuit interrupter) has to be installed.
- The power cable must meet the requirements according to the technical data (see section 8.4 Electrical data,  173).



For all work done with the housing open:

- If the Alyza IQ was already in operation:
Before opening the doors, start the maintenance routine at the terminal.
- Note the environmental conditions (see section 3.3.1 Requirements of the measurement location,  27).
- Open the outer housing door far enough so the arrestable brake-stay (on the lower right side of the housing) catches.
- Open the inner housing door far enough so that it touches the outer door. Tilt the angular sheet (at the inside of the outer door) over the upper edge of the inside door.

- 1 Open the outer housing door far enough so the arrestable brake-stay (on the lower right side of the housing) catches.

- 2 Open the inner housing door far enough so that it touches the outer door. Tilt the angular sheet (at the inside of the outer door) over the upper edge of the inside door.
- Switching off the power supply**
- 3 Switch off all filtration pumps (STOP).
 - 4 Switch off the 24 V power supply.
 - 5 Switch the power line potential free.
- Removing the mounting plate**
- 6 Unscrew the 2 fixing screws of the cover (on the top right side in the housing) and remove the cover of the ACM.
-  If the filtration pumps have already been in operation, sample liquid may escape when the tubes are unscrewed. Provide a collecting container in such a case.
- 7 Remove the cable connections and the connections of the tubes and liquid lines from the mounting plate:
 - Unplug the 2 cables from the switch box.
 - Unscrew the sample tubes from the overflow vessels.
 - Unplug the blue intake lines of the filtration unit.
 - 8 Remove the mounting plate:
 - Unscrew the 2 fixing nuts (3) at the bottom of the mounting plate.
 - Unscrew the 2 fixing screws (2) at the upper edge of the mounting plate.Secure the mounting plate against falling out.

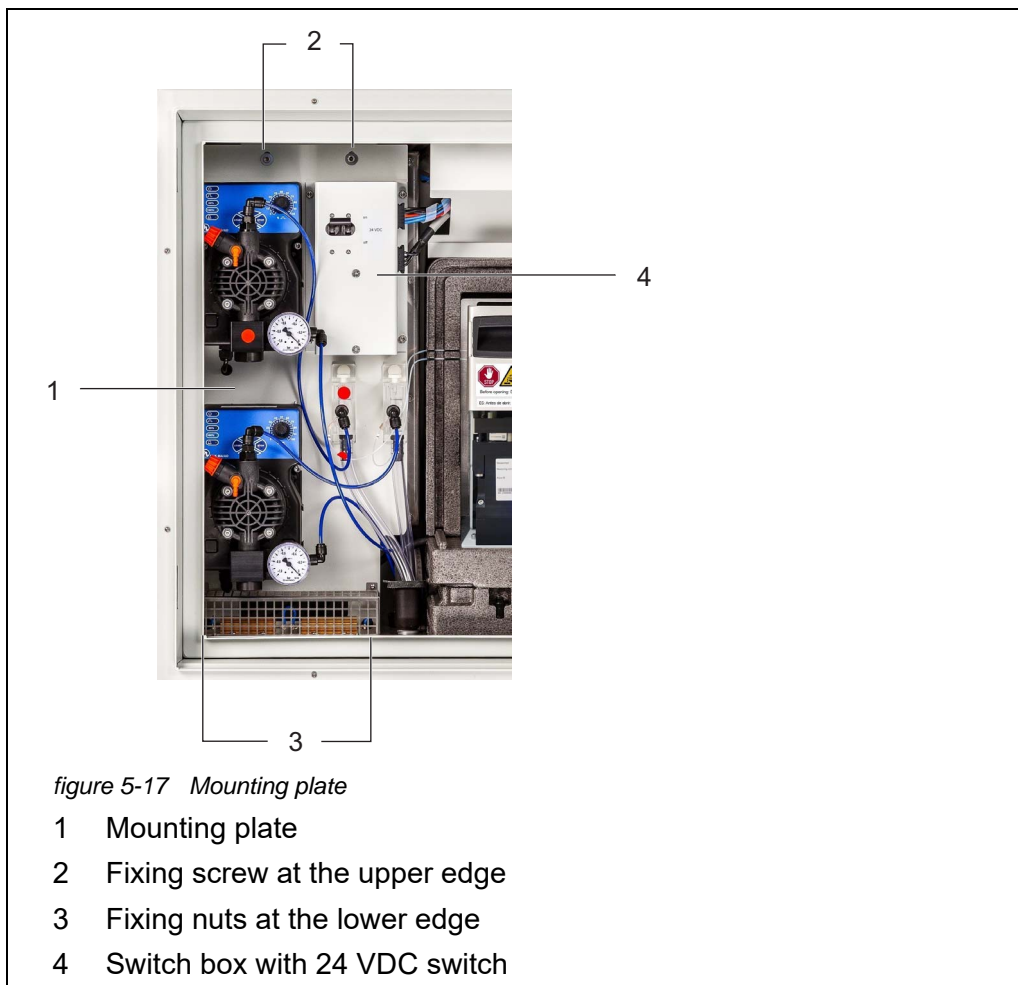

- 9 Remove the mounting plate:
- Lift the mounting plate upward over the threaded pins.
 - Tilt the upper edge of the mounting plate somewhat backwards and remove the mounting plate from the housing downwards.
 - Place the mounting plate with the rear side down on a protected surface (e.g. with cardboard).

Opening the power box

- 10 Unscrew all nuts with safety disks (10 pieces) from the power supply box and remove the lid of the power supply box.

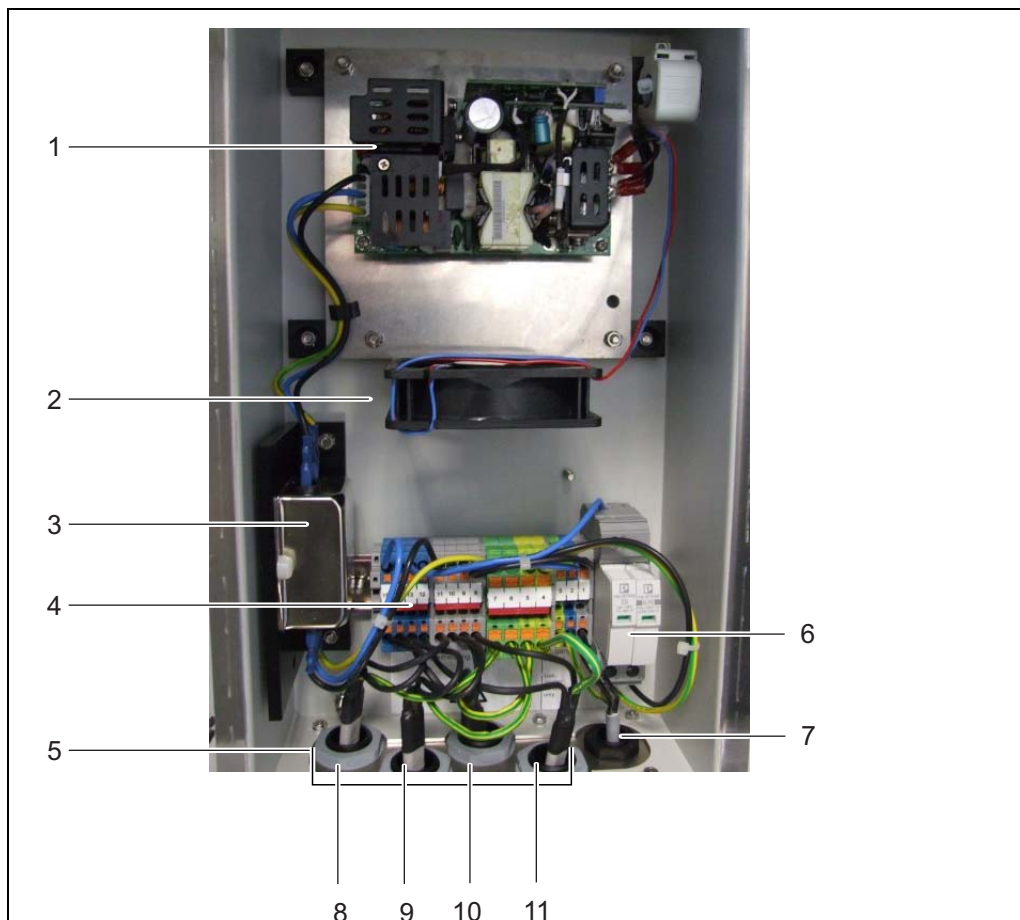



figure 5-18 Connections of the power supply box

- 1 Power supply module
- 2 Ventilator
- 3 Power supply filter
- 4 Connecting terminals for the heat tracing lines
 - 4 - 7: yellow/green (protective earth conductor)
 - 8 - 11: gray
 - 12 - 15: blue
- 5 Power supply of the heat tracing lines
- 6 Overvoltage protection
- 7 Power line
- 8 Cable gland for heat tracing of intake line (channel 1)
- 9 Cable gland for heat tracing of intake line (channel 2)
- 10 Cable gland for heat tracing of return line 1
- 11 Cable gland for heat tracing of return line 2

11 Carry out the maintenance activities at the power supply box.



Details on connecting the heat tracing and power cable:
See section 3.3.13 Connecting the power cable and heat tracing lines,  50.

- 12 Check whether all connections are made correctly.
- 13 Tighten the cable glands on the power supply box with a torque of 2.5 Nm.
The cable glands protect the power supply box from dust and moisture.



Make sure that no cable touches the power supply filter.

Closing the power supply box

- 14 Remount the lid of the power supply box and screw tight all nuts with safety disks as far as they will go (0.4 Nm).
The power supply box is closed and protected against dust and moisture.

Reinserting the mounting plate

- 15 Insert the mounting plate:
 - Plug the mounting plate on the threaded pins inside the housing.
 - Tighten the 2 fixing screws (2) at the upper edge of the mounting plate.
 - Tighten the 2 fixing nuts (3) at the bottom of the mounting plate.
- 16 Re-establish the cable connections and the connection of the tubes and liquid lines.
 - Plug the sample feed tubes onto the connectors of the filtration pumps.
 - Screw the sample tubes to the connectors of the overflow vessels.
 - Re-insert the sample return tubes into the collection funnel for the sample return.
 - Re-connect the 2 cables to the switch box.
- 17 Reinsert the cover and fix it with the 2 fixing screws.

Restoring the power supply

- 18 Switch on the mains power supply.
- 19 Switch on the 24 V power supply.
- 20 Switch on all filtration pumps (START).

Restarting the measuring operation

- 21 Complete the maintenance routine (see section 5.5.8,  122).

5.10 Emptying the system manually

NOTE

With manual emptying, there is the risk of material damage due to spilled chemicals.

Do not empty manually if it is possible to empty the system via the Alyza menu (see section 5.2 Opening the locking device of the MultiPort valve ("Before opening: Drain the system"),  101).

Emptying the system manually



For all activities at the open measuring unit:

- Note the environmental conditions (see fig. 3.3.1,  27).
- With low ambient temperatures, make sure that the liquids do not freeze while the maintenance activities are carried out. Leave the housing open for as short a time as possible.
- Open the outer housing door far enough so the arrestable brake-stay catches.
- Open the inner housing door far enough so that it touches the outer door. Tilt the angular sheet (at the inside of the outer door) over the upper edge of the inside door.



WARNING

Dangerous chemicals.

Improper use of chemicals can cause damage to your health.

Heed the following rules:

- **Read the labels of the ChemBags and follow the safety instructions**
- **Wear protective equipment (protective goggles, chemical resistant gloves)**

- 1 Open the outer housing door far enough so the arrestable brake-stay (on the lower right side of the housing) catches.
- 2 Open the inner housing door far enough so that it touches the outer door. Tilt the angular sheet (at the inside of the outer door) over the upper edge of the inside door.
- 3 Put on your personal protective equipment (PPE) and chemical resistant gloves (see section 2.4 Personal protective equipment (PPE),  24).

- 4 Remove the front cover of the measuring unit.
- 5 Using one hand, grip the handle at the upper edge of the front cover of the measuring unit.
- 6 Pull the front cover of the measuring unit somewhat to the front against the resistance.
- 7 Carefully take the front cover out to the front.
Put the front cover down in a clean place.
- 8 Guide all tubes of the ChemBags over the tube fasteners above the locking device and fix the tubes in tube fasteners.

NOTE

Damaged ChemBags may leak.

To avoid damage, the ChemBags must not be folded near the connector.

Hold the ChemBags at the connector, with the liquid downward.

To suspend the ChemBags from the supporting rod:

Carefully turn the ChemBags upside down, without folding the ChemBags or tubes.

- 9 Remove all ChemBags from the supporting rod one after the other and turn the ChemBags so the valves point upward.
Suspend the tubes of the empty ChemBags from the tube grooves at the photometer unit so that the ChemBags are suspended downwards from the tubes.
Place the ChemBags down with the connectors pointing upward.



figure 5-19 ChemBags removed from the supporting rod

- 10 Switch off all filtration pumps (STOP).
- 11 Switch off the 24 V power supply at the switch box.



If the filtration pumps have already been in operation, sample liquid may escape when the tubes and liquid lines are unscrewed. Provide a collecting container in such a case.

- 12 Unscrew the sample tubes from the overflow vessels.
- 13 Protect the sample tubes against loss of liquids and against the penetration of dust and dirt (e.g. with rubber plugs or absorbent paper).
- 14 Keep some absorbent paper ready to absorb small quantities of leaked liquids at the MultiPort valve.
- 15 Open the locking device of the MultiPort valve.
When the locking device is open, there is the risk of leaking chemicals.
- 16 Immediately place the absorbent paper onto the MultiPort valve.
- 17 Wait until the liquids have run back into the ChemBags.
- 18 Close the locking device of the MultiPort valve to absorb leaked liquids with the absorbent paper.



figure 5-20 Absorbent paper in the receptacle of the MultiPort valve

- 19 Open the locking device of the MultiPort valve.
- 20 Remove the absorbent paper.
- 21 Remove any remains of chemicals immediately.
- 22 Unscrew the tube couplings from the ChemBag connectors.
- 23 Close the ChemBag connectors with the yellow protection caps.
- 24 Store the ChemBags and secure them against being damaged.
- 25 Now carry out further actions, e.g.
 - Cleaning
 - Troubleshooting
 - Exchanging components
(see section 5.5 Installing / exchanging the ChemBags, MPV, tubes, [109](#))
 - Transport, storage
(see section 6.3 Transport, storage, [158](#))

5.11 SystemCheck

The *SystemCheck* function automatically checks whether the Alyza IQ is operable. It also brings the MultiPort Valve (MPV) into a defined basic state. The *SystemCheck* function is carried out regularly prior to every automatic calibration. You can start the *SystemCheck* function also manually (Alyza menu, tab *Maintenance / SystemCheck*).

If a component approaches a critical state, information messages with preventive maintenance instructions are issued.

Component	Explanation
<i>Photometer LED</i>	<ul style="list-style-type: none"> ● Function check of the LED of the photometer
<i>MPV detected</i>	<ul style="list-style-type: none"> ● Checking whether the serial number of the MultiPort valve (MPV) can be read.
<i>MPV initialized</i>	<ul style="list-style-type: none"> ● Aligning the MultiPort valve (MPV) to a defined basic position
<i>Syringe pump SP1</i>	<ul style="list-style-type: none"> ● Checking whether the syringe pump can create the required pressure
<i>Valve V2</i>	<ul style="list-style-type: none"> ● Checking whether a pressure applied to the valve is maintained (tightness of the valve) ● Checking whether the applied pressure decreases when the valve is open (permeability of the valve).
<i>Pressure sensor PS1</i>	<ul style="list-style-type: none"> ● Checking whether the pressure sensor (at atmospheric pressure) delivers a value in the valid range
<i>MPV tightness</i>	<ul style="list-style-type: none"> ● Checking whether the MultiPort Valve (MPV) can maintain the applied pressure
<i>Air condition</i>	<ul style="list-style-type: none"> ● Testing whether all elements for air-conditioning (heating elements, cooling elements, fans) are working



If an error occurs during the check of a component, the *SystemCheck* function is canceled and an error message is created.

No following checks will be performed.

Eliminate the error and then start the *SystemCheck* function manually to check the success of the maintenance (Alyza menu, tab *Maintenance / SystemCheck*).

6 Maintenance and cleaning (complex activities)

Decommission the Alyza IQ prior to carrying out one of the following activities:

- Dismounting the measuring unit
(e.g. for complex maintenance activities in the measuring unit)
- Transporting the Alyza IQ

Read the chapter 2 Safety instructions,  22 before doing any maintenance work. This is important for your personal safety.

NOTE

The interior of the measuring unit is temperature-controlled to 20 °C (68 °F). With ambient temperatures over 25 °C (77 °F) and high air humidity, condensation water may develop on the cool surfaces and cause damage when the measuring unit is opened.

To avoid damage to the measuring unit due to the formation of condensation water, always wait for the temperature adjustment (function Prepare to open measuring unit) to be completed before opening the measuring unit.

6.1 Decommissioning

6.1.1 Preparing the decommissioning



For all activities at the open measuring unit:

- Note the environmental conditions (see section 3.3.1 Requirements of the measurement location,  27).
- With low ambient temperatures, make sure that the liquids do not freeze while the maintenance activities are carried out. Leave the housing open for as short a time as possible.
- Open the outer housing door far enough so the arrestable brake-stay catches.
- Open the inner housing door far enough so that it touches the outer door. Tilt the angular sheet (at the inside of the outer door) over the upper edge of the inside door.

Starting the maintenance routine of the Alyza IQ

- 1 In the measured value display, use <▲ ><▼ > to select the Alyza IQ.

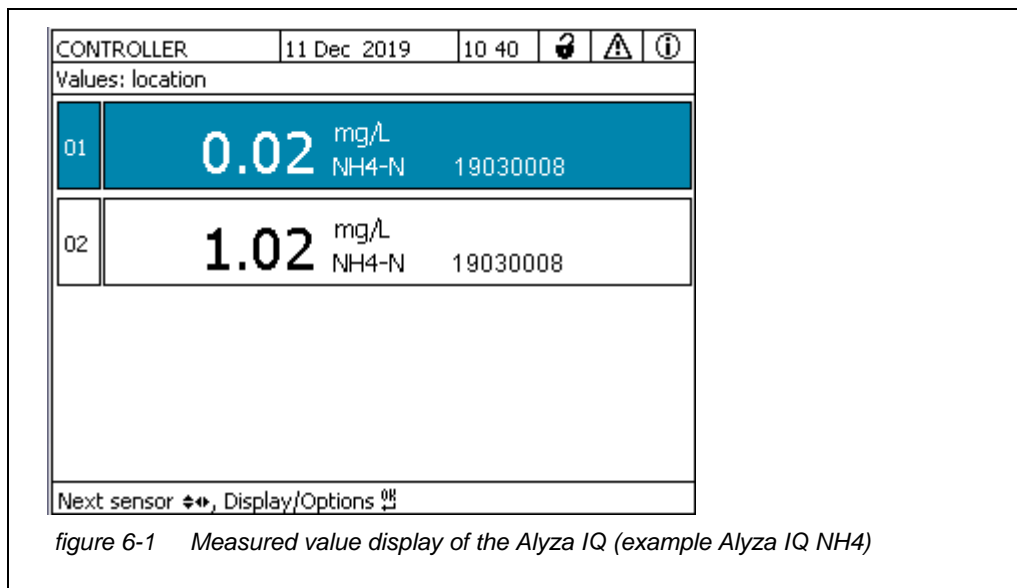

- 2 Using the <C> key, switch to the Alyza menu.
- 3 Using <left>, switch to the Maintenance tab.

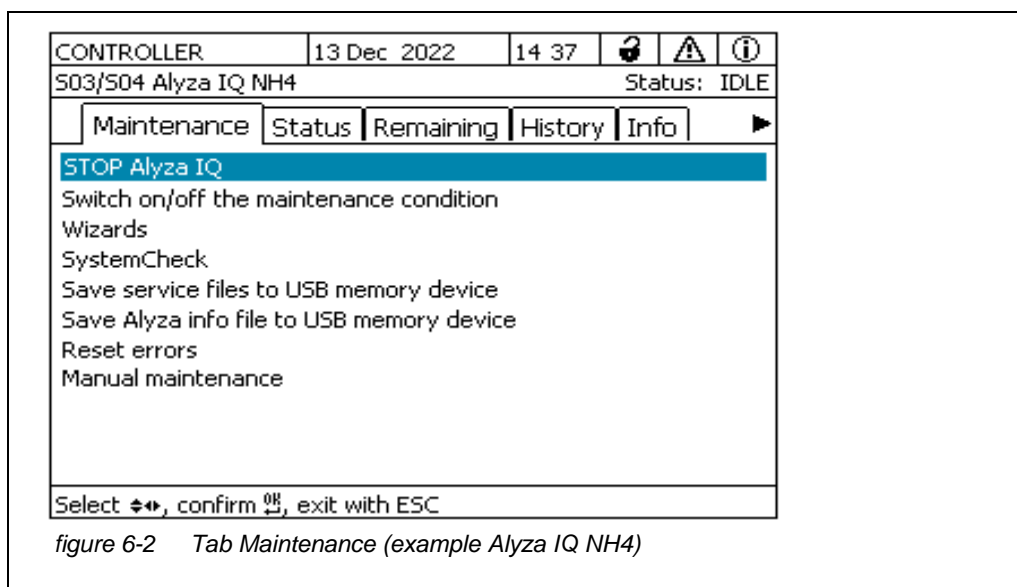

- 4 Carry out the STOP Alyza IQ function to stop the running operation.
- 5 Confirm the function to stop the running operation. The maintenance condition is automatically activated in the IQ SENSORNET for the Alyza IQ.

6.1.2 Decommissioning the measuring unit

- 1 Open the *Manual maintenance* menu.
- 2 Select the function, *Prepare to open measuring unit*.
Follow the instructions on the display.
The procedure starts the temperature adjustment of the measuring unit.
- 3 Drain the tubes (*Maintenance / Manual maintenance / Drain the system All*).
Follow the instructions on the display until the emptying is complete.
- 4 Open the outer housing door far enough so the arrestable brake-stay (on the lower right side of the housing) catches.
- 5 Open the inner housing door far enough so that it touches the outer door. Tilt the angular sheet (at the inside of the outer door) over the upper edge of the inside door.
The measuring unit is ready to be opened when the status LED of the measuring unit lights up white.

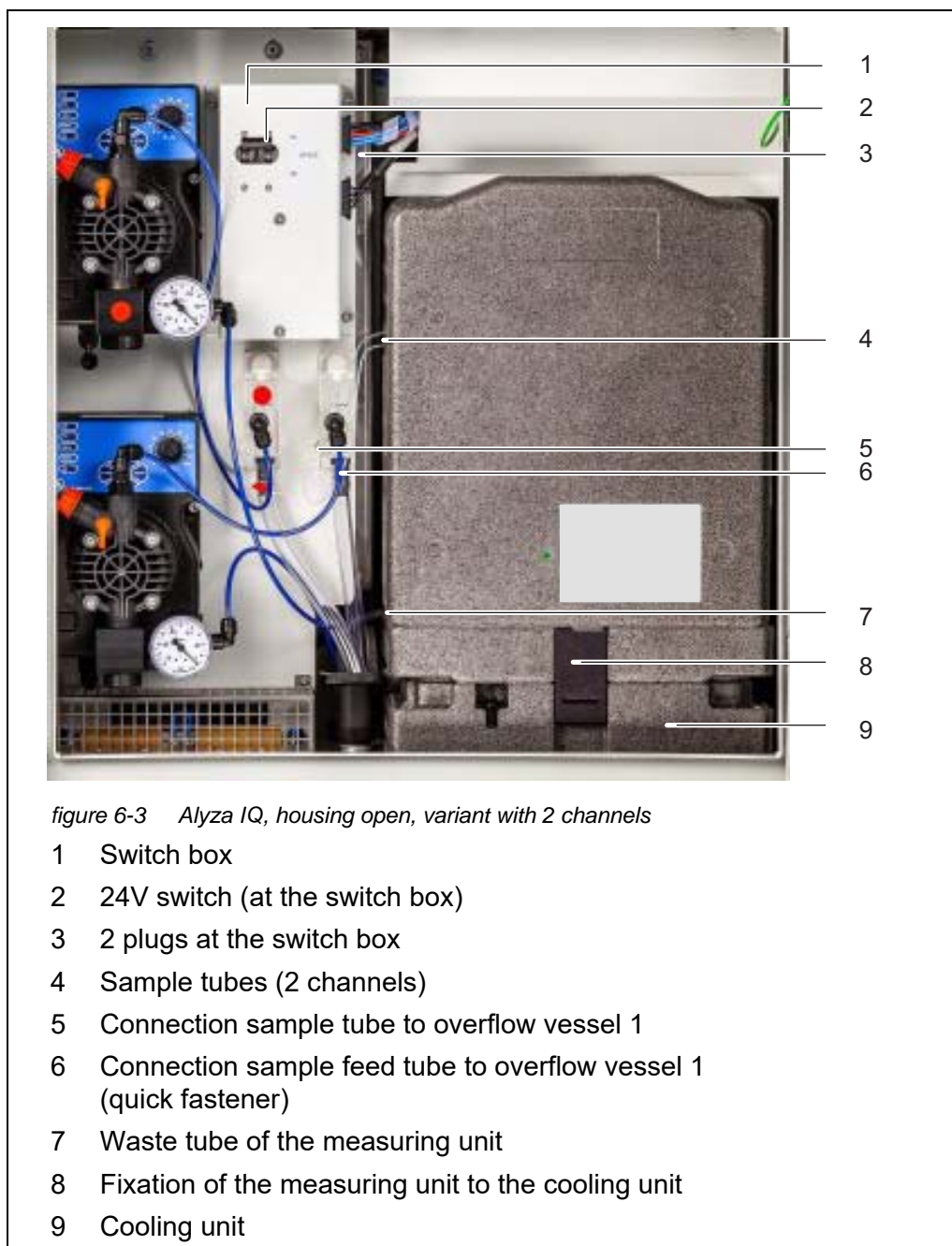

- 6 Switch off all filtration pumps (STOP).
- 7 Switch off the 24 V power supply at the switch box.

**WARNING****Dangerous chemicals.****Improper use of chemicals can cause damage to your health.****Heed the following rules:**

- **Read the labels of the ChemBags and follow the safety instructions**
- **Wear protective equipment (protective goggles, chemical resistant gloves)**



If the filtration pumps have already been in operation, sample liquid may escape when the tubes and liquid lines are unscrewed. Provide a collecting container in such a case.

- 8 Put on your personal protective equipment (PPE) and chemical resistant gloves (see section 2.4 Personal protective equipment (PPE), [24](#)).
- 9 Provide a collection container for the contents of the overflow vessel below the connection for the sample tube.
- 10 Unscrew the sample tube from the overflow vessel.
To do so, use the special tool in the base of the measuring unit.
The liquid exits the overflow vessel from the connection of the sample tube to the overflow vessel.
- 11 Drain the contents of the overflow vessel into the collection container provided. A rest of sample (approx. 3 ml) remains in the overflow vessel.
- 12 For Alyza IQ variants with 2 channels:
Repeat steps 9 - 11 for the second overflow vessel.
- 13 Pull the waste tube of the measuring unit out of the collection funnel.
- 14 Secure the waste tube against leakage of liquids (e.g. with rubber stopper or absorbent paper).
- 15 Now carry out the intended maintenance activities, such as:
 - Dismount the measuring unit and carry out maintenance activities (see section 6.2 Complex maintenance- and cleaning activities in the measuring unit, [152](#))or
 - Prepare the Alyza IQ for storage or transport (see section 6.3.2 PREPARING THE ALYZA IQ FOR TRANSPORT OR STORAGE).

6.1.3 Decommissioning for transport or storage

- 1 Decommission the measuring unit (see section 6.1.2 DECOMMISSIONING THE MEASURING UNIT).
- 2 Open the quick coupling of the sample feed tube at the overflow vessel.
- 3 Remove the remaining sample (approx. 3 ml) from the overflow vessel:
 - Open the lid of the overflow vessel.
 - Remove any remaining sample from the overflow vessel (e.g. using a plastic pipette).
 - Close the overflow vessel with the lid.
- 4 Empty the sample feed tube:
 - Pull the filter module (FM/PC) out of the basin.
 - Remove the intake line from the filter module (FM/PC) (see operating manual of the filter module (FM/PC)).
 - Protect the open connection and the open intake line against ingress of dirt.
 - Put the sample feed tube into the collecting container and secure it.
 - Switch on the filtration pump. Operate the filtration pump until the liquid residues are displaced from the sample feed tube.
 - Switch off the filtration pump (STOP).
 - Protect the filter module against drying out (see operating manual for the filter module FM/PC).
- 5 Then re-connect the sample feed tube to the overflow vessel.
- 6 For Alyza IQ variants with 2 channels:
Repeat steps 2 - 5 for the second overflow vessel.
- 7 Transport or store the Alyza IQ
(see section 6.3 Transport, storage, 158).

6.2 Complex maintenance- and cleaning activities in the measuring unit

For complex maintenance activities or cleaning activities in the measuring unit we recommend that you dismount the measuring unit and transport it to a clean laboratory environment.

When the measuring unit is dismounted, its parts are more easily accessible and the environmental conditions (temperature, cleanliness) are more suitable for complex maintenance activities or cleaning activities to be carried out.

6.2.1 Dismounting the measuring unit

- 1 Decommission the measuring unit of the Alyza IQ (see section 6.1 Decommissioning, [147](#)).
- 2 Secure the waste tube against leakage of liquids (e.g. with a rubber stopper or absorbent paper).
- 3 Check the collection tray for moisture.
In case of larger amounts of moisture:
Dry the collection tray before removing it (see section 5.5.6 Check the collection tray under the ChemBags for liquids, [117](#)).
- 4 Unscrew the 2 fixing screws of the cover lid of the control unit ACM and remove the cover lid of the ACM.
- 5 Unplug the 4 cables of the measuring unit from the control unit ACM and let them hang to the front over the measuring unit.

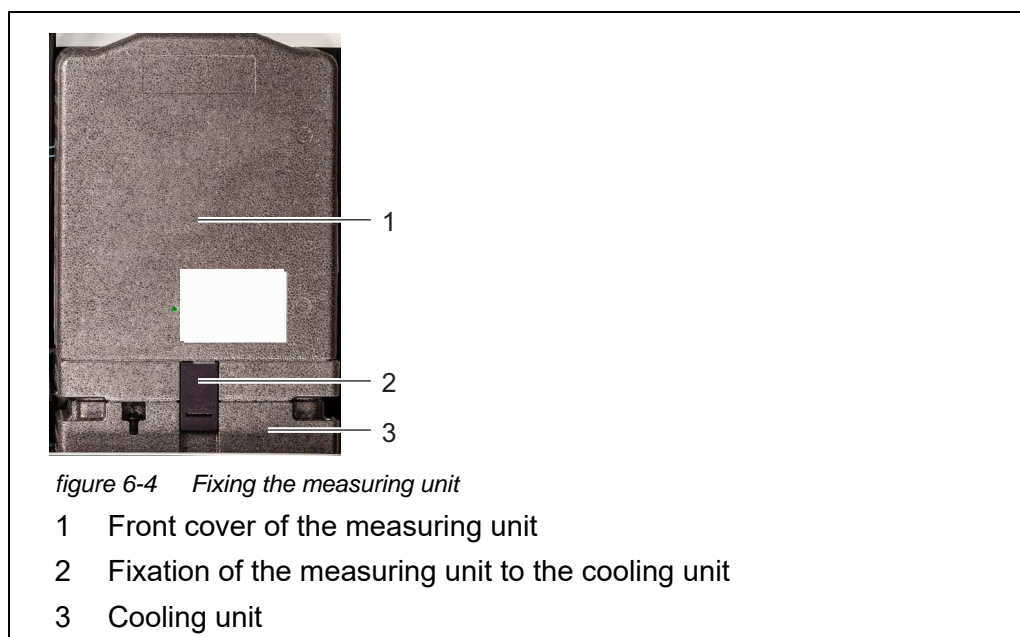

- 6 Using one hand, grip the handle at the upper edge of the front cover (1) of the measuring unit.
- 7 Pull the front cover of the measuring unit somewhat to the front against the resistance.
- 8 Carefully take the front cover out to the front.
Put the front cover down in a clean place.
- 9 Check whether there is liquid in the collection tray under the ChemBags (see section 5.5.6 Check the collection tray under the ChemBags for liquids, [117](#)).

- 10 Pull the fixation (2) of the measuring unit to the cooling unit out from below.
- 11 Take the measuring unit up off the cooling unit and tilt it backwards. Then remove the measuring unit from the housing of the Alyza IQ, to the front.
- 12 Put the measuring unit down in a flat and clean place.
- 13 Protect the cables, tubes, and measuring unit against loss of liquids and against the penetration of dust and dirt (e.g. with rubber plugs or absorbent paper).
- 14 Remove the cables hanging to the front of the measuring unit from the grooves at the back cover and lay them down.
- 15 Carry out the maintenance activities in the measuring unit.

6.2.2 Carrying out complex maintenance activities

Carry out the maintenance- or cleaning activities at the dismantled measuring unit, such as:

- Check the waste collector for coating and clean it (see section 6.2.3 Check the waste collector for coating,  154)



Details on further complex maintenance activities are given in the relevant documentation of the spare parts, e.g.:

- Syringe body
- Tubes of the photometer unit

6.2.3 Check the waste collector for coating

NOTE

A deposit in the waste collector (e.g. lime deposit) can obstruct the drainage of the liquids and cause damage due to overflowing liquids .

- 1 Dismounting the measuring unit (see section 6.2.1,  153)
- 2 Remove the ChemBags from the supporting rods (see section 5.5.5,  116).

NOTE

Damaged tubes may leak.

Folded or knotted tubes hamper the transport of the liquids. The tubes must not be damaged, folded or knotted.

- 3 Behind the ChemBags, unscrew the 2 screws for the rear cover of the measuring unit.

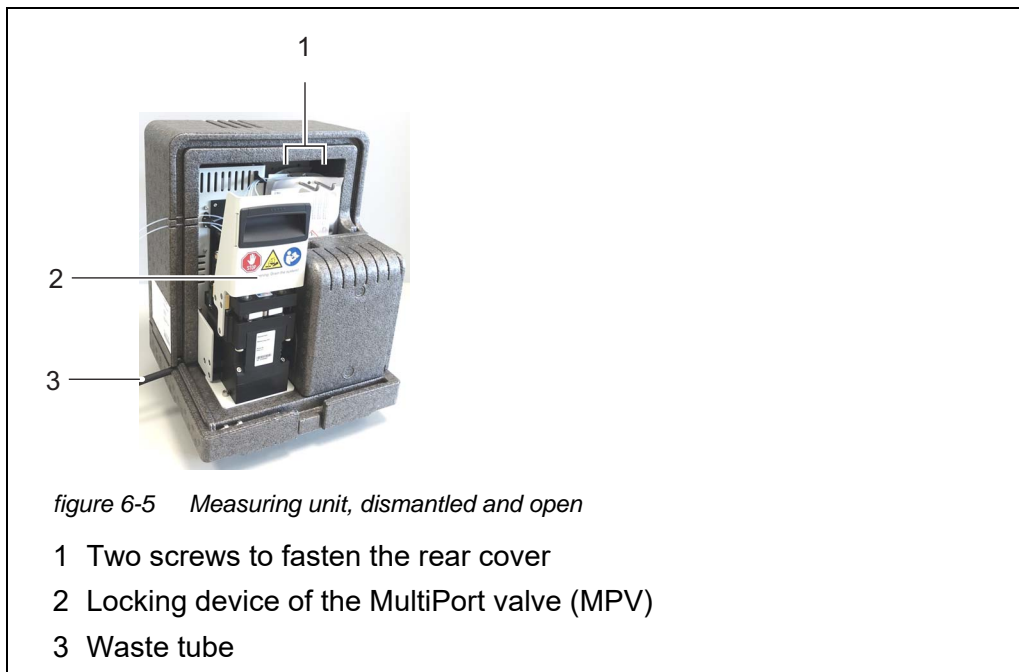

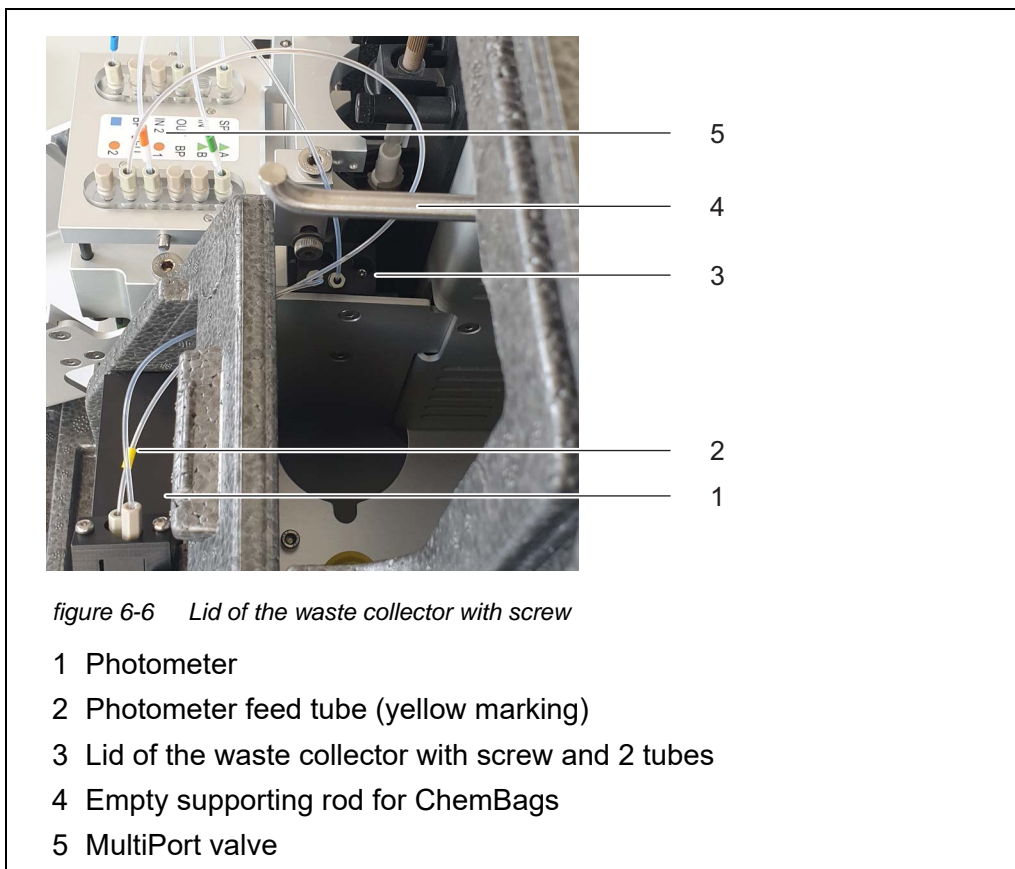

- 4 Tilt the rear cover of the measuring unit away to the rear.



- 5 Loosen the screw on the lid (3) of the waste collector.
- 6 Pull the lid (3) of the waste collector with the two hoses upwards until the bottom of the opened waste collector is visible.
- 7 Check the waste collector for the formation of a deposit, e.g. with a flashlight.



A deposit in the waste collector is an indication of lime in the water. If the deposit forms regularly, the additional installation of cleaning solution 2 is recommended.

- 8 If there is a visible deposit in the waste collector, clean the waste collector:
 - Close the waste tube with a rubber plug.
 - Insert the waste tube into a collection tray for liquids.
 - Using a syringe, fill the waste collector with 1 to 2 ml of cleaning solution (for lime: e.g. citric acid solution).
 - Allow the cleaning solution to act for approx. 15 min.
 - Remove the plug from the waste tube and drain the cleaning solution.
 - Check whether the deposit has dissolved.
 - If necessary, repeat the cleaning and allow the cleaning solution to act for a longer time.
 - If necessary, install cleaning solution 2 to remove minor lime deposits on a regular basis.
- 9 Place the lid (with the two tubes plugged in) back onto the open waste collector. The recess with the screw points to the rear.
- 10 Reinsert the rear cover of the measuring unit.
- 11 Reattach the rear cover with the 2 screws.
- 12 Hang the ChemBags back onto the supporting rod (see section 5.5.7,  119).
- 13 Remount the measuring unit (see section 6.2.4,  157).

6.2.4 Installing the measuring unit

- 1 Position the rear cover of the measuring unit at the measuring unit. Fix it to the measuring unit by tightening the 2 screws.
- 2 Close the measuring unit with the front cover.
- 3 Press the cables of the measuring units into the grooves of the back cover from the rear and let the plugs hang to the front.
- 4 Position the closed measuring unit on the cooling unit inside the housing of the Alyza IQ.
- 5 Tilt the measuring unit slightly backwards and press it onto the cooling unit.
The measuring unit must be tightly connected to the cooling unit so that no moisture can penetrate.
- 6 Mount the measuring unit to the cooling unit (with the fixation of the measuring unit).

- 7 Re-insert the waste tube into the collection funnel.
The liquid in the waste tube must be able to flow freely (steady slope, no kinking, no damage).
- 8 Screw the sample tubes of the measuring units to the overflow vessels.
The sample tube for overflow vessel 2 is labeled red.
- 9 Re-plug the 4 data cables of the measuring unit to the ACM.
- 10 Re-plug the 2 power supply cables to the switch box.
- 11 Reinsert the cover in front of the ACM and fix it with the 2 screws.

6.3 Transport, storage

6.3.1 General notes

Please observe the allowed environmental conditions for transport and storage of the Alyza IQ (see section 8.3 General data,  170).

Please note that no liquids or ChemBags may be in the Alyza IQ for storage and transport.

NOTE

Inappropriate transport and inappropriate storage of the Alyza IQ (especially of the measuring unit) can cause damage due to spilled liquids.

Safe transport and safe storage are only possible if the Alyza IQ is free from liquids (tubes, photometer unit, overflow vessels empty; ChemBags removed).



Even minor damage to tubes or ChemBags due to mechanical stress (e.g. pressure, shock etc.) or thermal impact (e.g. frozen liquids) can cause consequential damage due to spilled liquids.

6.3.2 Preparing the Alyza IQ for transport or storage

- 1 Decommission the Alyza IQ (see section 6.1 Decommissioning,  147)
- 2 Open the front cover of the measuring unit.
- 3 Remove all ChemBags from the measuring unit.
- 4 Remove the cover of the control unit ACM.
- 5 Unplug the 4 cables from the control unit ACM.
- 6 Close the measuring unit.

Preparing the measuring unit for transport or storage

- 7 Fix the measuring unit in its position inside the housing of the Alyza IQ with the 3 original transportation safety devices.

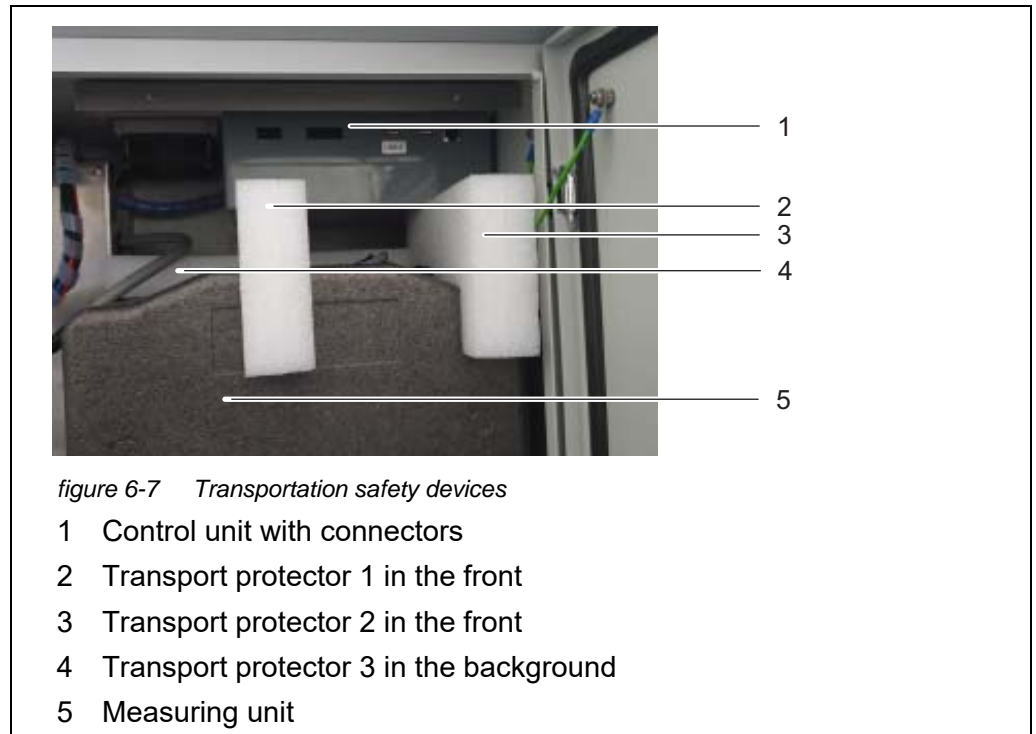

Preparing the basic instrument for transport or storage

- 8 Switch the power line potential free.
 9 Remove the mounting plate (section 3.3.13 CONNECTING THE POWER CABLE AND HEAT TRACING LINES).



WARNING

When the power supply box is open, there is a danger to life from electric shock. Observe the following points:

- The power supply box may only be opened when it is de-energized.
- The power supply box may only be opened by a qualified electrician.

- 10 Open the power supply box (see section 3.3.13 CONNECTING THE POWER CABLE AND HEAT TRACING LINES).
 11 Disconnect the cables of the heat tracings.
 12 Disassemble the liquid lines (with heat tracings):
- 1 or 2 intake lines (with heat tracings)
 - 1 or 2 return lines (with heat tracings)

- 13 Close the power supply box (see section 3.3.13 CONNECTING THE POWER CABLE AND HEAT TRACING LINES).
- 14 Reinstall the mounting plate (see section 3.3.13 CONNECTING THE POWER CABLE AND HEAT TRACING LINES)
- 15 Close the openings at the bottom of the housing again with the cable glands.
- 16 Close the doors of the Alyza IQ and secure the doors against inadvertent opening.
- 17 Disconnect the power line from the separator.
- 18 Disconnect the IQ SENSORNET cable of the Alyza IQ from the IQ SENSORNET module.
- 19 With the terminal holder installed:
 - Disconnect all IQ SENSORNET cables from the IQ SENSORNET module.
 - Remove the terminal holder (TM).
- 20 Secure the housing of the Alyza IQ against being damaged (e.g. by shock, overturning, falling, sliding, etc.).
- 21 Check the condition of the Alyza IQ with the checklist for transport and storage.

Preparing the ChemBags for transport or storage

- 22 For transport, pack the ChemBags leakproof and protected against any mechanical stress (e.g. shock, folding) and thermal impact (e.g. temperatures too high or too low).

Checklist storage and transport

- Is the Alyza IQ prepared for transport or storage (see section 6.1 Decommissioning, 147)?
- Is the system empty (tubes, MultiPort valve, photometer unit) ?
- Are the overflow vessels empty?
- Have all ChemBags been removed from the measuring unit and housing of the ?
- Is the measuring unit fixed inside the housing with the 3 original transportation safety devices?
- Are the housing doors closed and secured against inadvertent opening?
- Is the housing secured against shock, falling, overturning and sliding?

- 23 Transport or store the Alyza IQ.
- 24 Always transport or store the ChemBags separately from the measuring unit or housing of the Alyza IQ.

6.4 Recommissioning the Alyza IQ



On recommissioning, the data of the last used components (measuring unit, ChemBags) are automatically used again. Installing any components with the Install wizard is only required if other components should be installed.

- 1 For recommissioning, proceed in the same way as for the initial commissioning (see section 3 Commissioning,  25).

7 What to do if ...

Display “----”



Information on the cause of the indication is in the log book and in the Alyza menu / tab *Status*.

Cause	Remedy
No (valid) measured value available	Start measurement and wait for the measurement to be finished (10 min)
Three erroneous automatic calibrations in succession	<ul style="list-style-type: none"> ● Check the calibration standards (e.g. expiry date) ● Check the connection of the calibration standards ● Refill the tubes for the ChemBags with standard solutions <i>Alyza menu / tab Maintenance / Manual maintenance / Fill the system</i> ● Carry out a cleaning cycle <i>Alyza menu / tab Maintenance / Manual maintenance / Clean</i> ● Exchange calibration standards ● Contact the service department
<i>Status ERROR</i> The Alyza IQ is stopped General proceeding	<ul style="list-style-type: none"> ● View the details of the error e.g. in the Alyza menu / tab <i>Status</i> (display details with <OK>) or View the log book message ● Reset the error: (<i>Alyza menu, tab Maintenance / Manual maintenance / Reset errors</i>) ● Remedy the error ● <i>START Alyza IQ</i> ● If the <i>Status ERROR</i> is still there: Contact the service department

Cause	Remedy
<p><i>Status ERROR</i> The liquids from one or several ChemBags are not transported to the MultiPort valve</p>	<ul style="list-style-type: none"> ● View the log book message ● Check the filling level of the ChemBags ● Check the connection of the tubes ● Empty and refill the tube <i>Alyza menu / tab Maintenance / Manual maintenance / Drain the system and Fill the system</i>
<p><i>Status ERROR</i> Sample intake does not work</p>	<ul style="list-style-type: none"> ● Check the filtration pump ● Check and, if necessary, clean the filter plate ● Switch on the filtration pump ● Clean the overflow vessel and intake line
<p><i>Status ERROR</i> The temperature in the measuring unit or photometer unit Alyza IQ is outside the allowed range (e.g. due to the air circulation in the Alyza IQ being impeded)</p>	<p>Measuring (automatically or manually) is only possible if the operating temperature in both the measuring unit and photometer unit is in the allowed range.</p> <ul style="list-style-type: none"> ● Check for contamination and, if necessary, exchange the filter mats at the housing (see section 5.8.2, 134) ● Check for contamination and, if necessary, clean the bug screen ● Check for contamination and, if necessary, clean the condensate drain adapter

Cause	Remedy
<i>Status ERROR</i> Danger of condensation water forming in the measuring unit	<ul style="list-style-type: none"> ● View the details of the error e.g. in the Alyza menu / tab <i>Status</i> (display details with <OK>) or View the log book message ● Start the dehumidifying program for the measuring unit <i>Alyza menu / tab Maintenance / Manual maintenance / Dry the measuring unit</i> ● <i>START Alyza IQ</i>
Power failure	<ul style="list-style-type: none"> ● In the Alyza menu (tab <i>Maintenance</i>), start the Alyza IQ. ● If necessary, activate the function "Automatic start after power failure"
Unknown	See log book or Alyza menu / tab <i>Status</i> (display details with <OK>)

Display of OFL

Cause	Remedy
Measuring range exceeded	Select different measuring range
Calibration error	<ul style="list-style-type: none"> ● Check the calibration standards (e.g. expiry date) ● Check the connection of the calibration standards ● Refill the tubes for the ChemBags with standard solutions <i>Alyza menu / tab Maintenance / Manual maintenance / Fill the system</i> ● Carry out a cleaning cycle <i>Alyza menu / tab Maintenance / Manual maintenance / Clean</i> ● Exchange calibration standards ● Contact the service department
Measuring cell of the photometer unit dirty	<ul style="list-style-type: none"> ● Clean <i>Alyza menu / tab Maintenance / Manual maintenance / Clean</i> ● Contact the service department

Display of ERROR

Cause	Remedy
Alyza IQ is not properly connected	Check the assignment of the terminal connections
Communication between Alyza IQ and IQ SENSORNET is interrupted	Check the cable and connections
The electrical power supply of the Alyza IQ is interrupted	<ul style="list-style-type: none"> ● Check the power supply ● Check the maximum load

Implausible measured values

Cause	Remedy
Erroneous measurement	Wait for another measurement
Calibration error	<ul style="list-style-type: none"> ● Repeat calibration ● Check the calibration standards ● Check the connection of the calibration standards ● Refill the tubes for the ChemBags with standard solutions <i>Alyza menu / tab Maintenance / Manual maintenance / Fill the system</i> ● Exchange calibration standards ● Increase the time between cleaning and calibration.
Measured values always too high after cleaning	<p>Activate the function <i>Conditioning</i> (menu <i>Settings of sensors and diff. sensors / Autom.cleaning</i>).</p> <p>After cleaning, a rinse is carried out for each of the set number of steps and then a rinse with the sample and the added reagent.</p>

Cause	Remedy
Measuring cell of the photometer unit dirty	<ul style="list-style-type: none"> ● Carry out a cleaning cycle Alyza menu / tab <i>Maintenance / Manual maintenance / Clean</i> ● Contact the service department
Interferences e.g. in sample matrix	Select suitable measuring location
Photometer unit draws in air (e.g. air bubbles in the sample tube)	<ul style="list-style-type: none"> ● Reduce the pump capacity of the filtration pump (set to approx. 2 - 5 %). ● Check the screw couplings of the tubes for tightness.

Measuring mode cannot be set

Cause	Remedy
Alyza IQ is not stopped	Stop the Alyza IQ

Red signal LED at the measuring unit

Cause	Remedy
LED lights up red. Error causing the STOP of the Alyza IQ	Check and, if necessary, eliminate the error message in the log book
LED flashes red A beep is to be heard.	<ul style="list-style-type: none"> ● The front cover of the measuring unit is open. There is risk of damage due to the formation of condensation water within the measuring unit. Close the measuring unit immediately. After being open for 3 minutes, the measuring unit is automatically separated from the power supply to avoid damage due to a short-circuit on the PCB. To open the measuring unit for maintenance activities without any risk: <ul style="list-style-type: none"> – Before, start the function <i>Prepare to open measuring unit</i>. – Wait until the opening of the measuring unit is released ● The locking device of the MultiPort valve is open. There is a risk of damage due to leaking chemicals (see section 5.2,  101).

The system cannot be emptied via the Alyza menu

Cause	Remedy
<ul style="list-style-type: none"> ● Defective component, e.g.: <ul style="list-style-type: none"> – Syringe pump – MultiPort valve (MPV) – ACM – ACS – Power supply module – ... 	<ul style="list-style-type: none"> ● Empty the system manually (see section 5.10 Emptying the system manually, 142). ● Then exchange the defective component. ● Contact the service department

Storing the detailed operating data of the Alyza IQ

Cause	Remedy
e.g. request by service department	Transmit the detailed operating data of your Alyza IQ to a USB memory device (see section 4.6.2, 96).

Collection tray under the ChemBags is moist

Cause	Remedy
<ul style="list-style-type: none"> ● ChemBag is leaking ● MPV is leaking 	Empty the tray and dry it (e.g. with a paper towel) Caution, chemicals

8 Technical data

8.1 Measuring characteristics *NH4-N / NH3-N, NH4*

Measuring method Berthelot method in conjunction with an LED photometer

Measuring ranges and resolution

Measuring range	Measuring mode (citation form)	Measuring ranges	Resolution	Accuracy
Measuring range 1	<i>NH4-N</i> and <i>NH3-N</i>	0.02 .. 5.00 mg/L 0.02 .. 5.00 ppm	0.01	±2 % , ±0.02 ±2 % , ±0.02
	<i>NH4</i>	0.03 .. 6.00 mg/L 0.03 .. 6.00 ppm	0.01	±2 % , ±0.03 ±2 % , ±0.03
Measuring range 2	<i>NH4-N</i> and <i>NH3-N</i>	0.10 .. 20.00 mg/L 0.10 .. 20.00 ppm	0.01	±3 % , ±0.10 ±3 % , ±0.10
	<i>NH4</i>	0.13 .. 25.00 mg/L 0.13 .. 25.00 ppm	0.01	±3 % , ±0.13 ±3 % , ±0.13

All specifications concerning the measuring accuracy refer to the use of suitable standard solutions.



The display ranges are extended to 0.00 each at the lower measuring range limits.

Response time t90 < 10 min

Process variation coefficient

Measuring range	Process variation coefficient
1	< ±2%
2	< ±3%

Detection limit

Measuring range	Detection limit
1	≤ 0.01 mg/L <i>NH4-N / NH3-N</i>
2	≤ 0.03 mg/L <i>NH4-N / NH3-N</i>

8.2 Application conditions

Suitability and areas of application

The Alyza IQ analyzer is designed for online measurements of the ammonium concentration (NH₄) in aqueous samples (e.g. in the effluents of waste water treatment plants), and to control and regulate the elimination of ammonium in waste water treatment plants.

Requirements of the measuring medium (by the measuring unit)

Temperature	+4 ... +45 °C (+39 ... +113°F)
pH value	5...9
Solids contents	0 (max. particle size: 0.45 µm)
Bacteria	0 (as far as possible, free from bacteria)
Air bubbles	0 (as far as possible, free from air bubbles)
Required flow rate	Volume surge of the sample in the overflow vessel: < 1 ml/surge or, with quasi continuous supply: Volume flow of the sample in the overflow vessel: 1 ... 25 ml/min
Hardness	Total hardness < 3.5 mmol/l (20 °dH)



The requirements of the test sample are met by using the FM/PC filter module available as an accessory.

Requirements of the test sample (by the filtration system)

The FM/PC can be used if the test sample meets the following requirements.

Temperature	+4 ... +45 °C (+39 ... +113°F)
pH value	5...9
Solids contents	< 6 g/l

8.3 General data

Dimensions and weight

Component	Height x width x depth	Weight (without chemicals)
Housing with components	825 x 675 x 445 mm	up to approx. 50 kg (depending on equipment)

Front view:

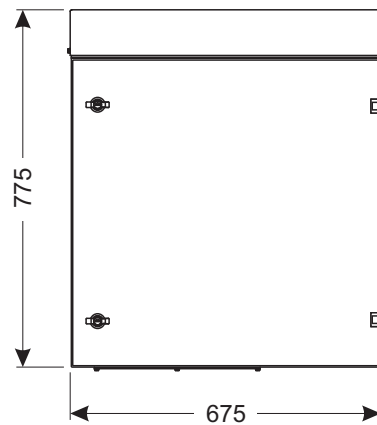

Lateral view:

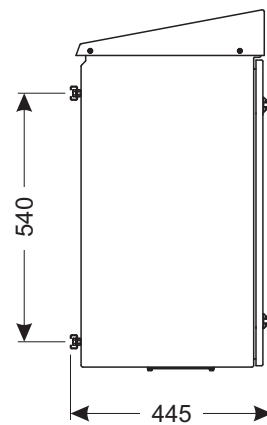

Required space

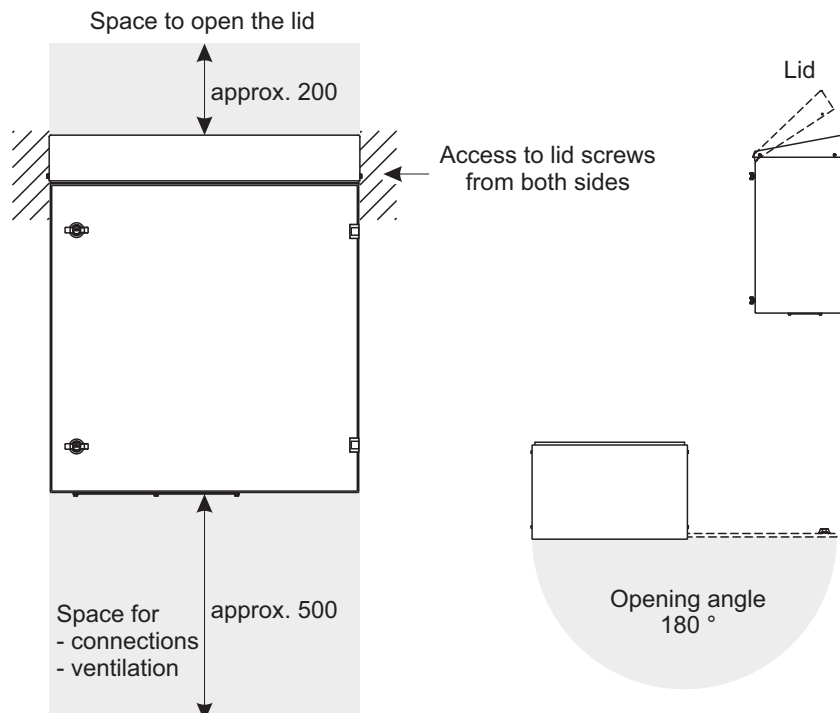

figure 8-1 Dimension drawing of Alyza IQ housing (dimensions in mm)

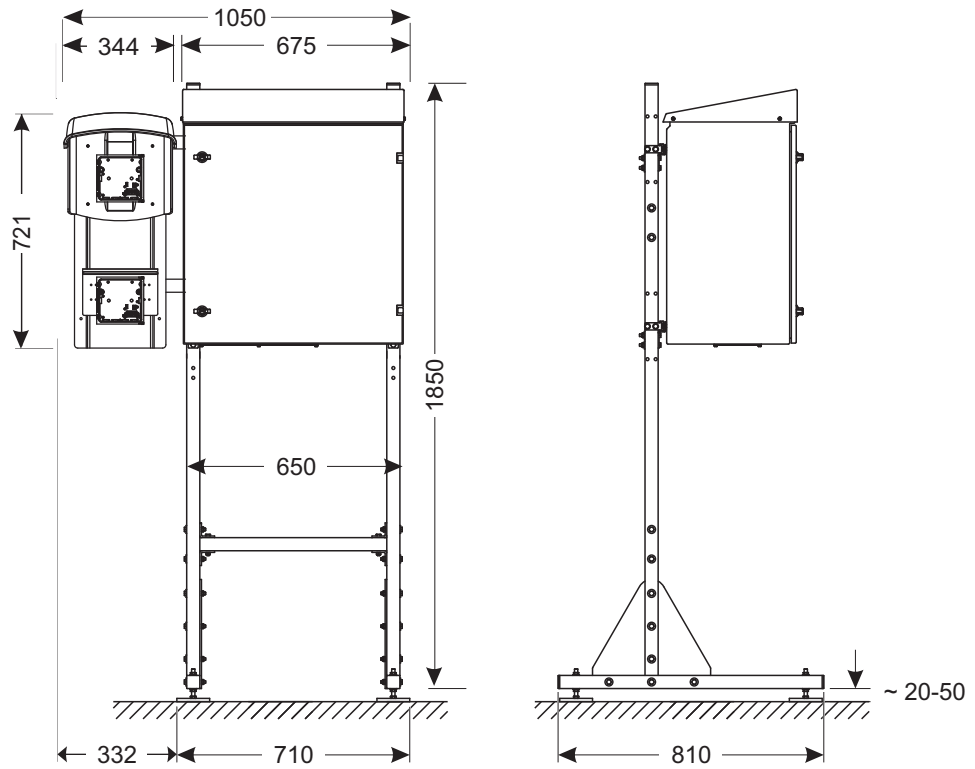

figure 8-2 Dimension drawing of Alyza IQ, installation on a mounting stand (dimensions in mm)

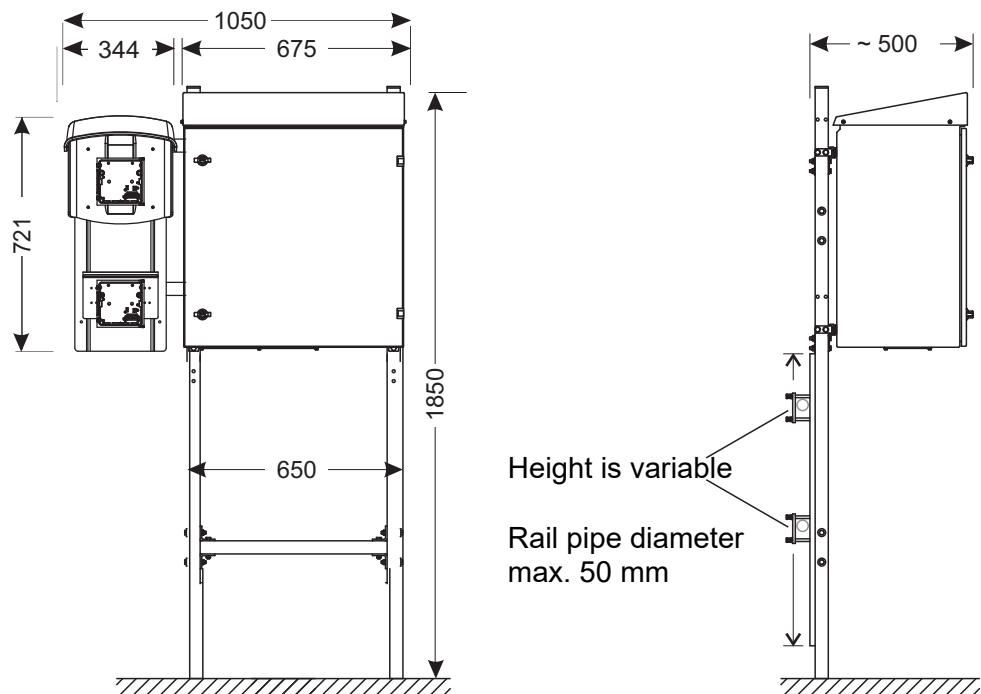

figure 8-3 Dimension drawing of Alyza IQ, rail mounting (dimensions in mm)

Connection technique

Connection to the IQ SENSORNET with the IQ SENSORNET cable

Ambient conditions

<p>Temperature range</p> <ul style="list-style-type: none"> ● Mounting/installation/maintenance ● Operation ● Storage 	<p>+ 5 ... + 40 °C (+ 41 ... +104 °F)</p> <p>- 20 ... + 40 °C (- 4 ... + 104 °F)</p> <p>- 20 ... + 50 °C (- 4 ... + 122 °F) (in completely empty condition)</p>
<p>Relative air humidity</p> <ul style="list-style-type: none"> ● Mounting/installation/maintenance ● Yearly average ● Dew formation 	<p>Max. 95 % (noncondensing)</p> <p>≤ 80 %</p> <p>≤ 90 %</p> <p>Possible</p>
<p>Environment</p>	<p>non-corrosive, non-saline. Operation in a moist, saline atmosphere (e.g. near the sea) can lead to corrosion of metallic components.</p>
<p>Measuring location</p> <ul style="list-style-type: none"> ● Site altitude ● Level of contamination 	<p>Indoors and outdoors</p> <p>Max. 4000 m above sea level</p> <p>2</p>
<p>Chloride concentration</p>	<p>< 500 mg/l (no sea water)</p>

Components

<p>Housing</p>	<p>Sunlight (UV) resistant Material: powder-coated aluminium Mounting plate: PVC</p>
<p>Housing of the measuring unit</p>	<p>EPP foam</p>
<p>Cable glands at the base plate</p>	<p>M40 x 1.5 (black, large): Clamping range 19 - 28 mm M20 x 1.5 (black, small): Clamping range 6.5 - 12 mm</p>
<p>Overflow vessel</p>	<p>Material: PMMA Required sample quantity: 1... 25 ml/min For correct measurements, enough sample must always be available in the overflow vessel.</p>
<p>Temperature control</p>	<p>Heating, cooling, ventilation</p>

Light source for photometer	LED, 660 nm (red)
MultiPort valve (MPV)	Material: PMMA, fluoroplastic, aluminum

Accessories

Mounting stand, wall mount and rail mount	Rails: Stainless steel V2A, Screws etc.: stainless steel V2A, V4A
Filtration unit	Membrane surface of the filter plate: 1300 cm ² Cut-off limit: < 0.45 µm Max. operating temperature: 45 °C (113 °F) Max. suction height: 5 m pH value: 2 ... 11.5 Housing: PVC Sleeve tube: PVC-reinforced PCV tube, transparent, 24 x 3 mm Intake line: PE 4 x 1 mm Line length (intake line, return line): Max. 20 m

Meter safety

Applicable norms	EN 61010-1 UL 61010-1 CAN/CSA C22.2#61010-1
Electromagnetic compatibility	EN 61326-1, EN 61326-2-3, FCC 47 CFR Part 15
Type of protection (housing)	IP 54 (EN 60529)
Type of protection (internal power supply box)	IP 67 (EN 60529)
Protective class	I
Overvoltage category	II

Test certificates CE, cETLus

8.4 Electrical data

Input voltage	120 V / AC ±10% / 60 Hz
Fuse protection of the building	16 A with ground fault circuit interrupter
Line power connection	3-pin, N/L /PE
Line cross-section of line power connection	Europe: 1.5 ... 4.0 mm ² USA: AWG 14 ... 12

Cable (requirements)	<p>Europe: IEC 60332-1-2 USA, Canada: UL 2556 VW-1 Details:</p> <ul style="list-style-type: none"> ● Temperature resistant in the range -20 °C...+80 °C (-68 °C...+176 °F), ● Weather-resistant (year-round) ● Watertight (cable sheath) ● Copper wire
<p>Power consumption Alyza IQ</p> <ul style="list-style-type: none"> ● Basic consumption ● Heat tracing, intake line return line 	<p>300 - 1600 W (depending on the length of the heat tracing)</p> <p>300 W</p> <p>16 W/m (max. 80 m heat tracing allowed)</p>
IQ SENSORNET cable (SNCIQ, SNCIQ/UG, SACIQ)	<ul style="list-style-type: none"> ● Insulation \geq 500 V ● Temperature resistant in the range -20 °C...+80 °C (-68 °C...+176 °F), ● Weather-resistant (year-round) ● Watertight (cable sheath)
Power delivery to the IQ SENSORNET	max. 10 W

8.5 Consumption data

The consumption of chemicals depends on the specified intervals and on the selected measuring range.

Typical consumption values

Solution	Sufficient for
Reagent solution R-NH4/1-1A/B/C (MR1) R-NH4/1-2A/B/C (MR2)	3 months (measuring interval 10 minutes) 1.5 months (measuring interval 10 minutes)
Cleaning solution C-NH4/1-1 C-NH4/1-2	6 months (daily cleaning) 6 months (daily cleaning)
Standard solution S-NH4/1-0.0/-1.0/-4.0/-16.0	3 months (daily calibration)

9 Lists

9.1 Explanation of the messages

This chapter contains a list of all message codes and the related message texts that can occur in the log book of the IQ SENSORNET system for the Alyza IQ analyzer.



Information on the contents and structure of the log book and the structure of the message code is given in the LOG BOOK chapter of the IQ SENSORNET system operating manual.

The last three digits of the message code form the component code. It identifies the component (active component) that caused the message:

Some error messages contain an internal error code, starting with "#".

Module code	Component
3E1	Alyza IQ NH4, channel 1
3E2	Alyza IQ NH4, channel 2
552	MIQ/Alyza (adapter ADA)

9.1.1 Error messages

Message code	Message text
EA1552	<i>Meas. range exceeded or undercut</i> * Check process * Select other meas. range
EA2552	<i>Sensor temperature too high!</i> * Check process and application
EA3552	<i>Sensor temperature too low!</i> * Check process and application
EAM552	<i>Meas. range exceeded or undercut</i> * Check process
EC1552	<i>Calibration error: Calibration standard could not be determined or is not suitable for current measurement range. Alyza IQ is stopped.</i> * Check the current measurement range * Check the calibration standard used

Message code	Message text
EI1552	<p><i>Operational voltage too low</i></p> <ul style="list-style-type: none"> * <i>Check installation and cable lengths, Follow installation instructions</i> * <i>Power supply module(s) overloaded, add power supply module(s)</i> * <i>Check terminal and module connections</i> * <i>Defective components, replace components</i>
EI2552	<p><i>Operational voltage too low, no operation possible</i></p> <ul style="list-style-type: none"> * <i>Check installation and cable lengths, Follow installation instructions</i> * <i>Power supply module(s) overloaded, add power supply module(s)</i> * <i>Check terminal and module connections</i> * <i>Defective components, replace components</i>
EI3552	<p><i>Operational voltage too low</i></p> <ul style="list-style-type: none"> * <i>Check installation and cable lengths, Follow installation instructions</i> * <i>Power supply module overloaded</i> * <i>Check terminal and module connections</i> * <i>Defective component, replace components</i>
EI4552	<p><i>Operational voltage too low, no operation possible</i></p> <ul style="list-style-type: none"> * <i>Check installation and cable lengths, Follow installation instructions</i> * <i>Power supply module overloaded</i> * <i>Check terminal and module connections</i> * <i>Defective component, replace components</i>
EI5552	<p><i>The measuring unit is not compatible!</i></p> <ul style="list-style-type: none"> * <i>Contact service</i>
EIA552	<p><i>Communication fault between MIQ/Alyza and ACM</i></p> <ul style="list-style-type: none"> * <i>Check cable connections</i> * <i>Check the power supply of the Alyza IQ</i> * <i>Contact service</i>
ES1552	<p><i>Component hardware defective</i></p> <ul style="list-style-type: none"> * <i>Contact service</i>
ES2552	<p><i>Component hardware defective xxx</i></p> <ul style="list-style-type: none"> * <i>Contact service</i>
ES3552	<p><i>Danger of condensation water forming in the measuring unit. The measuring unit is switched off.</i></p> <ul style="list-style-type: none"> * <i>Dry the measuring unit</i>

Message code	Message text
ES4552	<i>'Ready to measure could not be established after 1 hour. Alyza IQ was stopped. * Check climate control * Check/close doors, front cover of measuring unit. * Check IQ logbook and info window</i>
ES5552	<i>Communication failure with ACS * Check ACS connection</i>
ES6552	<i>Pressure on port xxx too high. * Check the liquid circle for errors and replace maintenance parts if necessary.</i>
ES7552	<i>Dosing of xxx failed several times * Make sure that tubes, ChemBags and couplings are free from air bubbles.</i>
ES8552	<i>Error initializing MPV and syringe pump. * Drain the system manually (see operating manual) * Replace the MPV * Contact service</i>
ES9552	<i>The locking device of the MPV is open. The Alyza IQ was stopped. * Close the locking device of the MPV</i>
ESA552	<i>Error of photometer LED: The Alyza IQ was stopped. * Contact service</i>
ESB552	<i>Error MPV: No MPV detected. The Alyza IQ was stopped. * Install the MPV correctly (see operating manual) * Contact service</i>
ESC552	<i>Error syringe pump: The Alyza IQ was stopped. * Contact service</i>
ESD552	<i>Pressure xxx too high. The Alyza IQ was stopped. * Contact service</i>
ESE552	<i>Error of valve V2: The Alyza IQ was stopped. * Contact service</i>
ESF552	<i>Error pressure sensor PS1: Pressure sensor PS1 defective. The Alyza IQ was stopped. * Contact service</i>
ESG552	<i>Error MPV tightness: The Alyza IQ was stopped. * Drain the system manually (see operating manual) * Replace the MPV immediately via Alyza menu</i>
ESH552	<i>Error MPV tightness: The Alyza IQ was stopped. * Drain the system via Alyza menu * Replace the MPV immediately via Alyza menu</i>

Message code	Message text
ESI552	<i>Fehler MPV Dichtigkeit: Der Alyza IQ wurde gestoppt. * Replace the MPV immediately via Alyza menu</i>
ESJ552	<i>ACS board cross changed! * Contact service</i>
ESK552	<i>New ACS board, missing backup! * Contact service</i>
ESL552	<i>ACS software too old, no restore to ACS board! * Update software</i>
ESM552	<i>ACS backup error xxx</i>
ESO552	<i>Power output into IQ SensorNet too high * Check installation and length, see installation instruction * Power supply overloaded, add power supply * Check clamping and modul connections * Replace defective devices</i>
ESP552	<i>Error drive blockade MPV: The Alyza IQ was stopped. Syringe pump locked. * Drain the system manually (see operating manual) * Contact service</i>
ESQ552	<i>Dosing of xxx failed several times. sample is missing. * Check sample flow</i>
ESR552	<i>Error MPV-positioning: The Alyza IQ was stopped. * Contact service</i>
ESS552	<i>'Climate control not fully functional! * Indoor temperature sensor defective * The Alyza IQ was stopped * Attention: Emergency operation due to danger of frost! * Contact service</i>
EST552	<i>'Climate control not fully functional! * Temperature sensor of the measuring unit defective * The Alyza IQ was stopped * Contact service</i>
ESU552	<i>'Climate control not fully functional! * Temperature sensor of the ACM control unit defective * Caution: Danger of condensation when opening the measuring unit! * Contact service</i>
ESV552	<i>Heating photometer defective! * Contact service</i>

Message code	Message text
ESW552	<i>Filling error: xxx</i>
ESX552	<i>Error MPV blocking: Alyza IQ was stopped. System was drained. * Check MPV and piping to syringe pump * Contact service</i>
ESY552	<i>Error MPV blocking: Alyza IQ was stopped. * Drain the system manually (see operating manual) * Check MPV and piping to syringe pump * Contact service</i>

9.1.2 Informative messages

Message code	Message text
IA1552	<i>Please check the remaining times of the ChemBags.</i>
IA2552	<i>Permissible internal temperature of the basic unit has been under-shot! Acute danger of frost! * Observe permissible outside temperature for operation * Keep doors closed * Check heater basic unit for blocking * In case of defect: Contact Service</i>
IA3552	<i>Permissible internal temperature of basic unit has been exceeded! * Keep doors closed * Check fan grille for blockage * Observe permissible outside temperature for operation * In case of defect: Contact Service</i>
IC2552	<i>Sensor still successfully calibrated, Calibration in limit range * Service sensor as soon as possible (see operating manual) * View calibration history * Check calibration conditions and calibration standard</i>
IC7552	<i>Calibration error: Calibration standard could not be determined or is not suitable for current measurement range. Calibration is rejected. Measurement will be continued with active valid calibration! * Check the current measurement range * Check the calibration standard used</i>

Message code	Message text
IC8552	<p><i>Calibration error: dosing or pressure error xxx. Calibration is rejected. Measurement will be continued with active valid calibration!</i></p> <p><i>* Make sure that tubes, ChemBags and couplings are free from air bubbles. * Check the liquid circle for errors and replace maintenance parts if necessary. * Clean the liquid circle</i></p>
IC9552	<p><i>Cleaning error: dosing or pressure error xxx. * Make sure that tubes, ChemBags and couplings are free from air bubbles. * Check the liquid circle for errors and replace maintenance parts if necessary. * Clean the liquid circle</i></p>
II1552	<p><i>Language not available, Default language German * Contact service</i></p>
IS1552	<p><i>The front cover of the measuring unit is open. Danger of condensation water. * Close the front cover of the measuring unit immediately</i></p>
IS3552	<i>MPV has been changed!</i>
IS4552	<i>Warning MPV tightness. MPV replacement recommended.</i>
IS5552	<i>ACS backup created!</i>
IS6552	<i>ACS backup restored!</i>
IS7552	<p><i>Missing USB flash drive or Alyza control file! * Contact service</i></p>
IS8552	<i>Cell exchanged!</i>
IS9552	<i>Vtot determined!</i>
ISA552	<i>VPark determined!</i>
ISB552	<i>Alyza IQ has been reconfigured!</i>
ISC552	<p><i>Temperature control not working properly! * Current interruption housing fan * Contact service</i></p>
ISD552	<p><i>Temperature control not working properly! * Housing fan * Contact service</i></p>

Message code	Message text
ISE552	<p><i>Temperature control not working properly!</i></p> <ul style="list-style-type: none"> * <i>Caution: frost danger if ambient temperature falls below 0°C</i> * <i>Power interruption of housing heating</i> * <i>Contact service</i>
ISF552	<p><i>Temperature control not working properly!</i></p> <ul style="list-style-type: none"> * <i>Heating of the basic instrument</i> * <i>Caution: frost danger if ambient temperature falls below 0°C</i> * <i>Contact service</i>
ISG552	<p><i>Temperature control not working properly!</i></p> <ul style="list-style-type: none"> * <i>Power interruption at the peltier element of cooling unit</i> * <i>Contact service</i>
ISH552	<p><i>Temperature control not working properly!</i></p> <ul style="list-style-type: none"> * <i>Peltier element of cooling unit</i> * <i>Contact service</i>
ISI552	<p><i>Temperature control not working properly!</i></p> <ul style="list-style-type: none"> * <i>Power interruption of outside fan peltier element</i> * <i>Peltier element turned off</i> * <i>Contact service</i>
ISJ552	<p><i>Temperature control not working properly!</i></p> <ul style="list-style-type: none"> * <i>Outside fan peltier element</i> * <i>Contact service</i>
ISK552	<p><i>Temperature control not working properly!</i></p> <ul style="list-style-type: none"> * <i>Current interruption inside fan peltier element</i> * <i>Peltier element turned off</i> * <i>Contact service</i>
ISL552	<p><i>Temperature control not working properly!</i></p> <ul style="list-style-type: none"> * <i>Inside fan peltier element</i> * <i>Contact service</i>
ISM552	<p><i>Temperature control not working properly!</i></p> <ul style="list-style-type: none"> * <i>Current interruption heating measure unit</i> * <i>Contact service</i>
ISN552	<p><i>Temperature control not working properly!</i></p> <ul style="list-style-type: none"> * <i>Heating of measuring</i> * <i>Contact service</i>
ISO552	<p><i>Internal voltage implausible</i></p> <ul style="list-style-type: none"> * <i>Contact service</i>
ISP552	<p><i>'Climate control not fully functional!</i></p> <ul style="list-style-type: none"> * <i>Humidity measurement of the ACM control unit defective.</i> * <i>Measurement is not affected.</i> * <i>Attention: Opening the measuring unit can take decidedly longer.</i> * <i>Contact service</i>

Message code	Message text
ISQ552	<i>Temperature control not working properly!</i> <i>* Housing fan turned off</i> <i>* Contact service</i>
ISR552	<i>Temperature control not working properly!</i> <i>* Heating of the basic instrument turned off</i> <i>* Caution: frost danger if ambient temperature falls below 0°C</i> <i>* Contact service</i>
ISS552	-
IST552	<i>Temperature control not working properly!</i> <i>* Peltier element of cooling unit turned off</i> <i>* Contact service</i>
ISU552	<i>Temperature control not working properly!</i> <i>* Outside fan and peltier element turned off</i> <i>* Contact service</i>
ISV552	<i>Temperature control not working properly!</i> <i>* Inside fan and peltier element turned off</i> <i>* Contact service</i>
ISW552	<i>Temperature control not working properly!</i> <i>* Heating of measuring unit turned off</i> <i>* Contact service</i>

9.2 Status info

The status info is a coded piece of information on the current status of a sensor. Each sensor sends this status info to the controller. The status info of sensors consists of 32 bits, each of which can have the value 0 or 1.

Status info, general structure

0	1	2	3	4	5	6	7	8	9	10	11	12	13	14	15	
1 0 0 0 0 0 0 0								0 0 0 0 0 0 0 0								(general)
0 0 0 0 0 0 0 0								0 0 0 0 0 0 0 0								(internal)
16	17	18	19	20	21	22	23	24	25	26	27	28	29	30	31	

The bits 0 - 15 are reserved for general information.

The bits 16 - 21 are reserved for internal service information.

You obtain the status info:

- via a manual query in the menu *Settings/Service/List of all components* (see IQ SENSORNET system operating manual)
- by an automated query
 - from a superordinate process control (e. g. when connected to the Profibus)
 - from the IQ Data Server (see IQ SENSORNET Software Pack operating manual)

The evaluation of the status info, e.g. in the case of an automated query, has to be made individually for each bit.

Status info Alyza IQ

Status bit	Explanation
Bit 0	<i>Component hardware defective</i>
Bit 1	<i>ERROR</i> The Alyza IQ is stopped
Bit 2	<i>Please check the remaining times of the ChemBags.</i>
Bit 3	-
Bit 4 - 31	-

10 Disposal

Handle and dispose of all waste in compliance with local laws and regulations.

EU only: Correct disposal of this product — WEEE Directive on waste electrical and electronic equipment

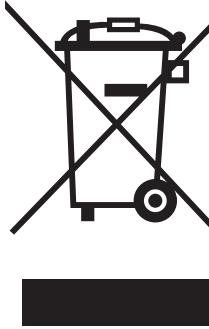

This marking on the product, accessories or literature indicates that the product should not be disposed of with other waste at the end of its working life.

To prevent possible harm to the environment or human health from uncontrolled waste disposal, please separate these items from other types of waste and recycle them responsibly to promote the sustainable reuse of material resources.

Waste from electrical and electronic equipment can be returned to the producer or distributor.

EU only: Correct disposal of batteries in this product

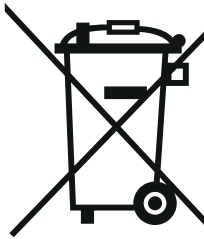

This marking on the battery, manual or packaging indicates that the batteries in this product should not be disposed of with other waste at the end of its working life. Where marked, the chemical symbols Hg, Cd or Pb indicate that the battery contains mercury, cadmium or lead above the reference levels in Directive 2006/66/EC. If batteries are not properly disposed of, these substances can cause harm to human health or the environment.

To protect natural resources and to promote material re-use, please separate batteries from other types of waste and recycle them through your local, free battery return system.

11 Appendix

11.1 Glossary

Absorbance	Logarithmic measure for the absorption of the sample; negative decadic logarithm of the transmission.
Adjusting	To manipulate a measuring system so that the relevant value (e. g. the displayed value) differs as little as possible from the correct value or a value that is regarded as correct, or that the difference remains within the tolerance.
Blank value	The blank value is the measured value of a measuring system if the measured parameter has the value zero or is nonexistent. The blank value has to be determined and subtracted from the measured values of the actual samples.
Calibration	Comparing the value from a measuring system (e. g. the displayed value) to the correct value or a value that is regarded as correct. Often, this expression is also used when the measuring system is adjusted at the same time. See «Adjusting».
Citation forms	Different display formats that can be derived from each other of the measured value for a concentration. The method for determining ammonium provides, for example, a measured value for nitrogen N. This measured value can be cited with the citation forms NH ₄ , NH ₄ -N or NH ₃ -N.
Concentration	Mass or amount of a dissolved substance per volume, e. g. in g/L or mol/L.
Deionized water	Water that was freed of minerals with the aid of an ion exchanger. Deionized water may still contain uncharged contamination such as organic compounds. It is also called DI water.
Firmware	The software permanently assigned to an instrument.
Ground fault circuit interrupter	Earth leakage circuit breaker. An electrical assembly group that switches off a circuit as soon as the strength of current in the phases does not exactly agree with the strength of current in the neutral conductor. The current difference can be caused by a grounded person inadvertently touching a live part of the circuit.
LED	Light emitting diode
Measured parameter	The measured parameter is the physical dimension determined by measuring, e. g. pH, conductivity or D.O. concentration.
Measured value	The special value to be determined of a measured parameter. It is given as a combination of the numerical value and unit (e. g. 3 m; 0.5 s; 5.2 A; 373.15 K).

Measuring system	A measuring system comprises all the devices used for measuring, e. g. meter and sensor. In addition, there is the cable and possibly an amplifier, terminal box and armature.
MSDS	Safety datasheets (Material Safety Data Sheets). Usually, the chemicals manufacturers provide safety datasheet with the chemicals delivered. The safety datasheets provide security relevant information on the substances delivered. MSDS can also be found on the Internet.
Operator	Legal designation for the owner of the system. The operator is responsible for the installed system, especially for the safety and training of the staff.
pH value	A measure of the acidic or basic effect of an aqueous solution. It corresponds to the negative decadic logarithm of the molal hydrogen ions activity divided by the unit of the molality. The practical pH value is the value of a pH measurement.
PPE	Personal protective equipment. The PPE includes clothing and other equipment that is used to protect you against risks at your place of work. You must always wear your PPE while doing dangerous jobs to avoid injuries or damage to your health. Typical examples are gloves, protective goggles, face protection shield, breathing protection, ear protection, safety helmet, safety shoes, fall protection. The PPE must fulfill the national standards and laws.
Reset	Restoring the original condition of all settings of a measuring system.
Resistance	Short name for the electrolytic resistivity. It corresponds to the reciprocal value of the electrical conductivity.
Resolution	Smallest difference between two measured values that can be displayed by a meter.
Slope	The slope of a linear calibration function.
Standard solution	A solution whose measured value is known per definition. It is used to calibrate a measuring system.
Test sample	Designation of the test sample ready to be measured. Normally, a test sample is made by processing the original sample. The test sample and original sample are identical if the test sample was not processed.
Transmission	The part of the light that goes through the sample.

12 Contact Information

12.1 Ordering & Technical Support

Telephone: (800) 897-4151
(937) 767-7241
Monday through Friday, 8:00 AM to 5:00 PM ET

Fax: (937) 767-1058

Email: info@ysi.com

Mail: YSI Incorporated
1725 Brannum Lane
Yellow Springs, OH 45387
USA

Internet: www.ysi.com

When placing an order please have the following information available:

- YSI account number (if available)
- Model number or brief description
- Quantity
- Name and Phone Number
- Billing and shipping address
- Purchase Order or Credit Card

12.2 Service Information

YSI has authorized service centers throughout the United States and Internationally. For the nearest service center information, please visit www.ysi.com and click 'Support' or contact YSI Technical Support directly at 800-897-4151.

When returning a product for service, include the Product Return form with cleaning certification. The form must be completely filled out for an YSI Service Center to accept the instrument for service. The Product Return form may be downloaded at www.ysi.com and clicking on the 'Support' tab.

Xylem |'zīləm|

- 1) The tissue in plants that brings water upward from the roots;
- 2) a leading global water technology company.

We're 12,500 people unified in a common purpose: creating innovative solutions to meet our world's water needs. Developing new technologies that will improve the way water is used, conserved, and re-used in the future is central to our work. We move, treat, analyze, and return water to the environment, and we help people use water efficiently, in their homes, buildings, factories and farms. In more than 150 countries, we have strong, long-standing relationships with customers who know us for our powerful combination of leading product brands and applications expertise, backed by a legacy of innovation.

For more information on how Xylem can help you, go to www.xylem.com



a **xylem** brand

YSI
1725 Brannum Lane
Yellow Springs, OH 45387
Tel: +1 937-767-7241; 800-765-4974
Fax: +1 937-767-1058
Email: info@ysi.com
Web: www.ysi.com

©Xylem Inc